



centric
creating spaces



CONTENTS

task seating.....	4
reception.....	16
bench desking.....	20
everyday desking.....	28
height adjustable desking.....	35
monitor arms & power.....	38
wooden storage.....	42
executive.....	46
steel storage.....	50
lockers.....	52
shelving.....	54
seating.....	56
multi purpose tables.....	78
training, conference & boardroom..	82
reception seating.....	96
acoustic pods.....	122
screens.....	125
fabrics & finishes.....	128



Welcome to Centric's new product guide, offering you our exciting range of products.

We are proud to showcase our extensive collection of products from many of the country's leading furniture manufacturers, the extensive portfolio of desking, seating, storage, screens and leisure products are chosen for their design, quality, functionality - and outstanding value for money.

DESIGN, Centric specialise in office design, bringing together interior and workplace design to create efficient, imaginative, offices that capture the spirit of your business.

PLANNING AND INSTALLATION, all installations are undertaken by trained staff and at times to suit you, all packaging is removed for recycling.

TRAINING, we can provide on site ergonomic training to make sure users are familiar with our products ensuring correct seating and posture.



CENTRIC TASK CHAIRS

The CEN101-202 chairs are a popular choice as the classic entry level task chair, proven through their quality, durability and comprehensive range of variations and options.

CEN101-202 are available with two different mechanisms, including a permanent contact back (PCB) and an independent seat and back mechanism (ISB). CEN101-202 features two back size options, height adjustable or fixed arms. The CEN101-202 ranges include a draughtsmans chair.

A new addition is the CEN101 mesh - the essential task chair fitted with an eye-catching mesh back. The mesh back is ergonomically shaped, height adjustable and available in six different colours.

The CEN101 MESH can be specified with a PCB or ISB mechanism. Options such as the polished aluminium base give chair the appearance and feel of a top of the range chair.

CEN 101



CEN101
Task chair PCB



CEN101D
Draughtsmans chair

CEN101
Task chair ISB

CEN101P MESH
Mesh back chair adjustable
arms PCB



CEN101AA
Task chair adjustable arms PCB

CEN101R MESH
Mesh back chair adjustable
arms ISB

CEN 202



CENP202
Task chair no arms PCB

CENR202
Task chair no arms ISB

CENP202D
Draughtsmans chair
no arms PCB



CENR202COMP
Task chair adjustable fold down arms
Seat slide Pump up lumbar

accessories CEN101 and CEN202

Ring arms
Adjustable arms
Fold down arms
Seat slide

Pump up lumbar
Satin base
Polished base
Soft tyre castors

PROACTIVE ERGONOMICS

The CEN 400 range of task chairs has consistently been our best-selling chair for the last 10 years because of its proactivity in the fight against bad back issues in the workplace.

CEN 400

features and options

Height adjustable ratchet back rest
Moulded seat foam for increased comfort and longevity
ISB (Independent Seat and Back adjustment),
Extra high back combined with large seat
Optional fixed, height adjustable or height adjustable
fold down arms

Orthopaedic task chair fitted with dual density extra thick, split foam seat pad, lumbar pump, adjustable foldaway arms and seat slide.

Tested and certified to BS 5459

CENR414COMP
Task chair



CENR404
Extra high back ergonomic
task chair ISB



ergonomic accessories CEN400

Neckrest
HT Adjustable arms
Fold Down Arms
Split Density Foam Seat

Pump up Lumbar
Polished Base
Satin Base

Seat Slide
Coccyx cut out
Soft Tyre Castors

CEN 600

An office chair with a slightly different look. The square, more contemporary design of the backrest and seat, combined with its ergonomic benefits and quality make the CEN 600 a popular, reliable and affordable task chair choice.

ISB or PCB mech available.

accessories CEN600

HT adjustable arms
Seat slide
Pump up lumbar
Polished base
Soft tyre castors



CEN600
Highback no arms
ISB CENR603
PCB CENP603



CEN600AA
Highback height adjustable arms
ISB CENR603 AA
PCB CENP603 AA

**FIVE
YEAR
WARRANTY**

CEN MESH

The 700 Mesh has the combination of a stylish and breathable mesh back with ergonomic features and easy adjustment. In addition, we have also introduced a variety of mesh colours for the backrest.

CEN5717MCMS AA
CENMESH complete with
adjustable arms, seat slide
and split density foam seat,
black base

Coloured mesh back
also available



WHITE



GREY



BLUE



GREEN



RED

FREEFLEX

The Freeflex task chair designed by Justus Kolberg provides a clever and adaptable chair solution to support users movements in their working environment.

Innovation and user insights have come together to create a chair which not only looks stylish but pushes ergonomic boundaries.



FLX740HA

With height adjustable arms

OSCAR

Everything has been considered in the design and production of Oscar - user requirements, materials, styling, sustainability and end-of-life recycling.

Considerable attention to detail has been spent on ergonomics; lumbar and pelvic support as well as ease of use and comfort. By focussing on these features, it has removed the need for 'tank-like' assemblies under the seat, keeping lines clean, simple and flowing.

Frame colours Black, Grey & White.

Mesh Colours Yellow, Blue, Orange, Black, Dark or Light Grey

OSCAR

With height adjustable arms



Orthopaedica

CEN 9000



Designed to provide the user with the ultimate level of postural support with sculptured seat and back cushions, makes it an ideal choice for those with back problems.

The fit of the chair can be enhanced by additional options including seat depth adjustment, inflatable lumbar, inflatable thorax and a choice of arms with height adjustable as standard although a multifunctional arm pad may be fitted.

For the ultimate postural support a coccyx cut out has been incorporated into the seat design. Possibly the most unique addition is the AirTech seat board, a body responsive seat support that moulds and adapts to your every movement.

Every individual is unique in their proportions, which is why we developed a range of back heights within the Orthopaedica range. The mid back variation is built with a laminated core; the 9000 Series is available with an upholstered outer and inner back.

CEN9000

Complete with fold down arms, Airtech seat, inflatable lumbar, seat slide with synchro mechanism.



CEN 9500

The expansion of the Orthopaedica range has led to the creation of the Ultra high back, to offer the user the ultimate in support and comfort. Developed with a laminated core structure for additional strength, the 9500 Series features a fully upholstered back.



CEN9500

Complete with fold down arms, Airtech seat, inflatable lumbar, seat slide with synchro mechanism and inflatable thorax.



INFLATABLE LUMBAR & THORAX

By using the pneumatic pump, the lumbar or thorax can be inflated or deflated as required to meet individual user requirement



AIRTECH SEAT BOARD

A push of the button allows air to flow through the two way valve; this enables the seat to move as you move and moulds to your natural shape

TEN
YEAR
WARRANTY



At Humanscale, we believe that the highest level of functionality is achieved through simplicity. With our chairs, we replace heavy, complex mechanisms with the sitter's own body weight and the laws of physics to encourage movement, providing the most comfortable chair available.



FREEDOM HEADREST

Designed by Niels Diffrient
Described by The New York Times as "the gold standard in office seating", the Freedom chair redefines the concept of traditional task chairs. Designer Niels Diffrient aimed to design an office chair that automatically adapts to the user, allowing them to move freely from posture to posture.



FREEDOM

Diffrient's unique approach removed complexities found in other chairs, such as cumbersome recline levers and back tension dials for a truly ergonomic task chair. As a result, he developed a recline mechanism that perfectly adjusts to the user, definitively reinventing modern task seating to be truly simple, functional, and beautiful.

WATCH THE
VIDEO





Our longstanding partnership with legendary designer Niels Diffrient produced our award-winning Freedom, Diffrient World, and Liberty chairs. We also collaborate with respected industrial designers such as Don Chadwick and Todd Bracher on new seating products.



DIFFRIENT WORLD

Designed by Niels Diffrient

Diffrient World is Humanscale's first foray into all-mesh task seating. Designer Niels Diffrient wanted to create the most minimal, full-function task chair ever made. With an innovative tri-panel mesh backrest that provides custom back and lumbar support and a lightweight design, Diffrient World is, like all of Humanscale's products, simple, beautiful and functional. The design eliminates the need for traditional mechanisms, instead using the laws of physics and the sitter's body weight to offer perfect recline for each individual sitter. Diffrient World offers the ultimate user-friendly sitting experience



LIBERTY

Designed by Niels Diffrient

The Liberty Task chair is an intelligent mesh task chair engineered to provide automatic lumbar support for every user, as well offering simplicity and complete ease of use. Liberty was designed to offer a unique, minimal aesthetic and to provide custom comfort for every person who sits in it. Like Humanscale's Diffrient World chair, Liberty uses Humanscale's revolutionary Form-Sensing Mesh Technology and mechanism-free recline for perfect support and unprecedented comfort.

CEN 24/7

24 hour facilities where people work around the clock require the right equipment. It is important to have the best chair to ensure performance throughout the working day/night, when concentration is a must.

The 24/7 has been designed for constant use, to give high levels of comfort using moulded foam with a sturdy internal steel structure. Specify with fabrics that will cope with the demands of 24/7 environments.

The CEN 24/7 features a high performance fully adjustable mechanism providing easy adjustment and dynamic sitting to suit the 24/7 environment. The weight setting is up to 190kg/30 stone.

The Xtra high back version offers an integral neckrest that adjusts backwards and forwards to support the users neck and shoulders.



CEN24/7AM

With height adjustable arms,
high back



CEN24/7PM

With height adjustable arms,
Xtra high back

KAB

A 24 hour chair for primary use in surveillance and control stations. Also ideal for deluxe office environments. The standard version features a robust leather fabric combination, providing maximum durability and comfort for 24/7 usage.



KAB Controller features

- 200kg (31 stone) rated gas lift
- KAB Tilt System (allows for regular posture change)
- 24 hour use certified
- Inflatable lumbar pump for lower back support
- Seat height adjustment
- Height & weight adjustment

2 YEAR WARRANTY
24 HOUR USE
UP TO 35 STONE

KAB1
Controller chair in
Leather/Curacao

BROMLEY

A chair that offers superb comfort and functionality. Ideal for heavy duty use in Police, Security, Air Traffic Control rooms and other 24 hour working environments. Perfect when user needs to be seated for long periods of time, 24/7, 365 days a year. Exceeds level 'S' certification.

**FIVE
YEAR**
WARRANTY
WITH 24 HOUR
FABRIC



AXR24/7A22
High back with A22
multi-function
push button arms

AXR24/7A22
High back with
headrest and A22
multi-function
push button arms





BESPOKE RECEPTION

Recent projects have included a 13-metre-long, free-standing cantilever counter top using a steel frame anchored to the floor for the University of Birmingham, a reception desk with built-in cash till drawers for a leisure centre in Wiltshire, and another reception desk for Lloyds Register in London.

The bespoke side of the business has really taken off. There's a growing appetite for individual design and items that create an instant impression and reinforce the personality of a business or workplace.

Items like reception desks are the most obvious place to do this and it's the most popular request, but we also create bespoke soft seating that makes the most of existing space.





17



17





We're finding that existing clients are coming back to us for more items too.

We believe that's because our bespoke products are engineered to a high standard - as well as the service and aftercare we can provide.





HAVEN POD SYSTEM

CHEMISTRY
Personal Storage Drawers with seat pads

MONITOR ARMS

EVOLVE CHAIR

CHEMISTRY Meeting Table
Shown with cut-out for cable basket



CHEMISTRY
Desk End Storage

CHEMISTRY

Chemistry is a Modular Bench system ordered as a starter, or add on desk. It is available in a back to back or inline format with options for fixed or sliding tops, standard or 'O' legs.

The system can be fully cable managed and the inset mid-leg is manufactured to accommodate a vertical wire management cassette as an option.

The twin beam system on fixed tops and 'outriggers' on sliding tops add to the rigidity of this system. Height adjustable and height settable desks are included within the range as are screens and storage.

CHEMISTRY
Height adjustable desking



**FIVE
YEAR**
WARRANTY

EVERYDAY BENCH DESKING

Everyday Bench Desking offers a simple yet practical working solution for the modern everyday office. This versatile range gives a strong clean image in a crisp design which delivers intelligent results.





**2 Person Rectangular Desk
Back to Back - 1600mm deep**

EVFBCD18-2	1800w
EVFBCD16-2	1600w
EVFBCD14-2	1400w
EVFBCD12-2	1200w

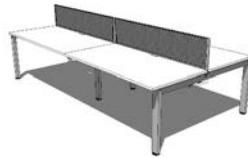

**4 Person Rectangular Desk
Back to Back - 1600mm deep**

EVFBCD18-4	3600w
EVFBCD16-4	3200w
EVFBCD14-4	2800w
EVFBCD12-4	2400w

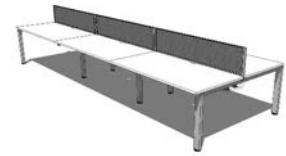

**6 Person Rectangular Desk
Back to Back - 1600mm deep**

EVFBCD18-6	5400w
EVFBCD16-6	4800w
EVFBCD14-6	4200w
EVFBCD12-6	3600w



**Rectangular Desk
800mm deep**

EVFBCS18-1	1800w
EVFBCS16-1	1600w
EVFBCS14-1	1400w
EVFBCS12-1	1200w



**2 Person Rectangular Desk
Side by Side - 800mm deep**

EVFBCS18-2	3600w
EVFBCS16-2	3200w
EVFBCS14-2	2800w
EVFBCS12-2	2400w



**3 Person Rectangular Desk
Side by Side - 800mm deep**

EVFBCS18-3	5400w
EVFBCS16-3	4800w
EVFBCS14-3	4200w
EVFBCS12-3	3600w



**Fabric Screen
400mm high**

EVFBFU18	1800w
EVFBFU16	1600w
EVFBFU14	1400w
EVFBFU12	1200w



**Fabric Screen with Tool Rail
400mm high**

EVUSTO418	1800w
EVUSTO416	1600w
EVUSTO414	1400w
EVUSTO412	1200w

Single Horizontal Cable Basket

FBBA18	1800w
FBBA16	1600w
FBBA14	1400w
FBBA12	1200w

Double Horizontal Cable Basket

FBDA18	Double
FBDA16	Double
FBDA14	Double
FBDA12	Double

Screen Fixing Bracket

FBFBKT1	in line single desk
FBFBKT2	back to back desk

Vertical Cable Basket

BBCCM

**METAL
Mobile Pedestals**

METMP	565h
-------	------



**Wood
Mobile Pedestals**

CONMP	631h
-------	------

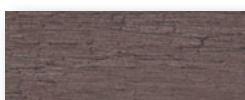

Winter Oak

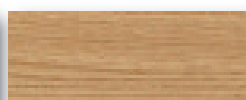

Strata Oak



Autumn



White

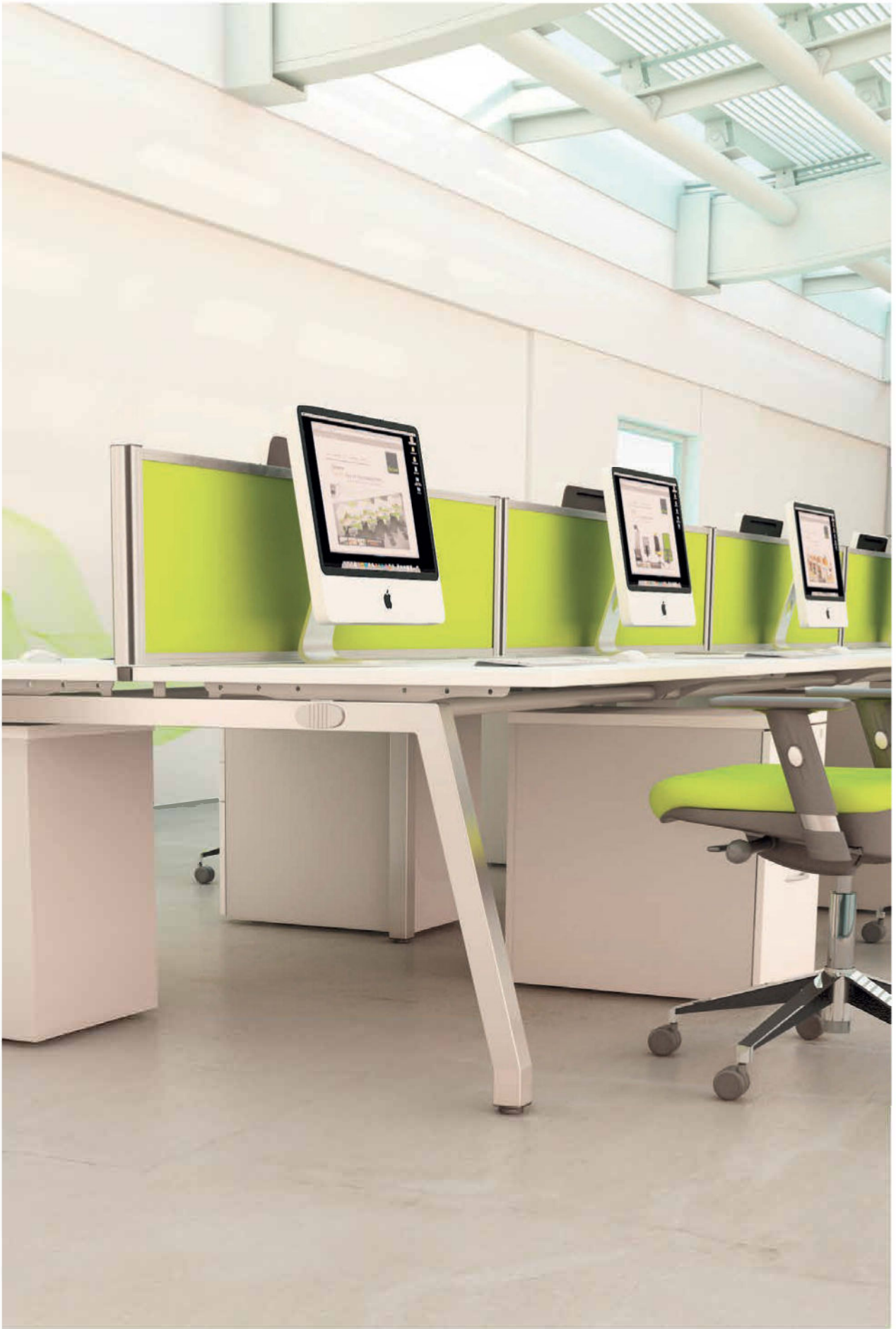

BENCH²

Scallop Top Desking

2 Person Rectangular Bench back to back

BFS2016Z	2000x1600
BFS1816Z	1800x1600
BFS1616Z	1600x1600
BFS1416Z	1400x1600
BFS1216Z	1200x1600
BFS1016Z	1000x1600

4 Person Rectangular Bench back to back

BFS42016Z	4000x1600
BFS41816Z	3600x1600
BFS41616Z	3200x1600
BFS41416Z	2800x1600
BFS41216Z	2400x1600
BFS41016Z	2000x1600

6 Person Rectangular Bench back to back

BFS62016Z	6000x1600
BFS61816Z	5400x1600
BFS61616Z	4800x1600
BFS61416Z	4200x1600
BFS61216Z	3600x1600
BFS61016Z	3000x1600

1 Person Rectangular Bench Side by Side

BFS2008Z	2000x800
BFS1808Z	1800x800
BFS1608Z	1600x800
BFS1408Z	1400x800
BFS1208Z	1200x800
BFS1008Z	1000x800

2 Person Rectangular Bench Side by Side

BFS22008Z	4000x800
BFS21808Z	3600x800
BFS21608Z	3200x800
BFS21408Z	2800x800
BFS21208Z	2400x800
BFS21008Z	2000x800

3 Person Rectangular Bench Side by Side

BFS32008Z	6000x800
BFS31808Z	5400x800
BFS31608Z	4800x800
BFS31408Z	4200x800
BFS31208Z	3600x800
BFS31008Z	3000x800

2 Person Wave Bench back to back

BWS21816Z	1800x1000x1600
BWS21616Z	3200x1000x1600
BWS21416Z	2800x1000x1600
BWS21216Z	2400x1000x1600

4 Person Wave Bench back to back

BWS41816Z	3600x1000x1600
BWS41616Z	3200x1000x1600
BWS41416Z	2800x1000x1600
BWS41216Z	2400x1000x1600

6 Person Wave Bench back to back

BWS61816Z	5400x1000x1600
BWS61616Z	4800x1000x1600
BWS61416Z	4200x1000x1600
BWS61216Z	3600x800x1600

1 Person Wave Bench side by side

BWS1808Z	1800x1000x800
BWS1608Z	1600x1000x800
BWS1408Z	1400x1000x800
BWS1208Z	1200x1000x800

2 Person Wave Bench side by side

BWS21806Z	3600x800x600
BWS21606Z	3200x800x600
BWS21406Z	2800x800x600
BWS21206Z	2400x800x600

3 Person Wave Bench desk side by side

BWS31806Z	5400x800x600
BWS31606Z	4800x800x600
BWS31406Z	4200x800x600
BWS31206Z	3600x800x600

Available as stand alone and single sided bench.

Fixed top.

Clean lines with scallop edge feature for cable access.

Optional desk top screens and modesty panels available.



MESA

Rectangular Desking & Clusters

Access Top

Mesa is a stripped back bench desk range that combines strength with ease of assembly and use. Available in a concise selection of popular footprints, allowing specifiers to confidently plan their workspace.

It's simple structure and shared components makes Mesa the ideal cost-effective desking solution for linear clusters. 43mm deep scallop feature for cable access.

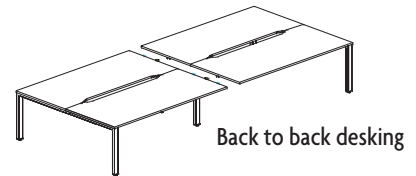
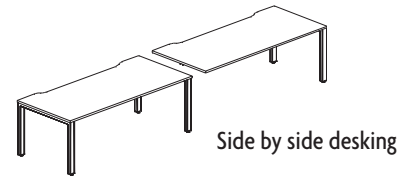

2 person desk back to back

MEF22016Z	2000x1600
MEF21816Z	1800x1600
MEF21616Z	1600x1600
MEF21416Z	1400x1600
MEF21216Z	1200x1600
MEF21016Z	1000x1600

4 person desk back to back

MEF42016Z	4000x1600
MEF41816Z	3600x1600
MEF41616Z	3200x1600
MEF41416Z	2800x1600
MEF41216Z	2400x1600
MEF41016Z	2000x1600

6 person desk back to back

MEF62016Z	6000x1600
MEF61816Z	5400x1600
MEF61616Z	4800x1600
MEF61416Z	4200x1600
MEF61216Z	3600x1600
MEF61016Z	3000x1600

1 person desk stand alone

MEF2008Z	2000x800
MEF1808Z	1800x800
MEF1608Z	1600x800
MEF1408Z	1400x800
MEF1208Z	1200x800
MEF1008Z	1000x800

2 person desk side by side

MEF22008Z	4000x800
MEF21808Z	3600x800
MEF21608Z	3200x800
MEF21408Z	2800x800
MEF21208Z	2400x800
MEF2008Z	2000x800

3 person desk side by side

MEF32008Z	6000x800
MEF31808Z	5400x800
MEF31608Z	4800x800
MEF31408Z	4200x800
MEF31208Z	3600x800
MEF31008Z	3000x800





**TEN
YEAR
WARRANTY**

MESA

Single & Double Wave Desking

2 person back to back wave desking

MEWC21816Z	1800x1600x1200
MEWC21616Z	1600x1600x1200
MEWC21416Z	1400x1600x1200
MEWC21216Z	1200x1600x1200

4 person back to back wave desking

MEWC41816Z	3600x1600x1200
MEWC41616Z	3200x1600x1200
MEWC41416Z	2800x1600x1200
MEWC41216Z	2400x1600x1200

6 person back to back wave desking

MEWC61816Z	4200x1600x1200
MEWC61616Z	3600x1600x1200
MEWC61416Z	
MEWC61216Z	

Right-handed 800/600mm single sided wave desking

MEWR2008Z	2000x800x600
MEWR1808Z	1800x800x600
MEWR1608Z	1600x800x600
MEWR1408Z	1400x800x600
MEWR1208Z	1200x800x600



Left-handed 800/600mm single sided wave desking

MEWL2008Z	2000x800x600
MEWL1808Z	1800x800x600
MEWL1608Z	1600x800x600
MEWL1408Z	1400x800x600
MEWL1208Z	1200x800x600



800/600mm double sided wave back to back

MWC2016Z	2000x1600x1200
MEWC1816Z	1800x1600x1200
MEWC1616Z	1600x1600x1200



EVERYDAY DESKING

Everyday offers a straightforward range of shapes and sizes for the ever-demanding office environment.



Wave Desk

Available left and right hand 1000/800d x 730mm

EVSSW18 L or R 1800mm

EVSSW16 L or R 1600mm

EVSSW14 L or R 1400mm

EVSSW12 L or R 1200mm



Workstation Radial

Available left and right hand 1170/730d x 730mm

EVASRS18 L or R 1800mm

EVASRS16 L or R 1600mm

EVASRS14 L or R 1400mm



Rectangular Desk

800 x 730mm

EVAS18 1800mm

EVAS16 1600mm

EVAS14 1400mm

EVAS12 1200mm

EVAS10 1000mm

EVAS8 800mm



Wave Screen
420/230mm

- EVWV180 Fabric screen 1800mm
- EVWV160 Fabric screen 1600mm
- EVWV140 Fabric screen 1400mm
- EVWV120 Fabric screen 1200mm

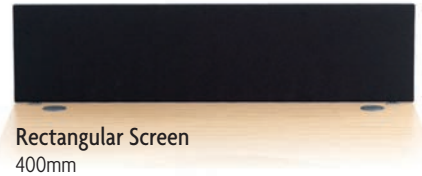

Rectangular Screen
400mm

- EVS180 Fabric screen 1800mm
- EVS160 Fabric screen 1600mm
- EVS140 Fabric screen 1400mm
- EVS12 Fabric screen 1200mm
- EVS10 Fabric screen 1000mm
- EVS80 Fabric screen 800mm



- 4 Person Unit complete with:
- 4 x 1600mm workstations
 - 4 x desk high pedestals
 - 4 x 1600 wave screens with Cara fabric



Double Door Cupboard
EVSDRS7 730h
EVSDR12 1200h
EVSDR16 1600h
EVSDR20 2000h



EVST16
Medium tambour unit 1600h
Includes 1 shelf



EVSST7
Low tambour unit 730h



EVONDH8
Desk high pedestal
430x800

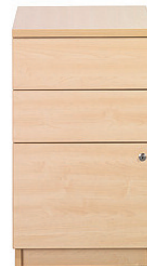

EVONDH6
Desk high pedestal
430x600



EVSM3
Mobile pedestal 3 drawer

CENKIT
Desking



CENKIT Rectangular, Wave & Workstations

- Available in Cantilever and Panel End versions
- Cantilever available with optional end frame covers
- Available in a variety of desk & workstation footprints
- Delivered and installed fully assembled



Cenkit Cantilever

Cenkit Panel End

800mm Deep Rectangular Desking

KVD728Z	1800x800
KVD638Z	1600x800
KVD568Z	1400x800
KVD488Z	1200x800
KVD408Z	1000x800
KVD318Z	800x800



Left Hand - Wave Desking

K8DWL18Z	1800x800x1000
K8DWL16Z	1600x800x1000
K8DWL14Z	1400x800x1000
K8DWL12Z	1200x800x1000



Right Hand - Wave Desking

K8DWR18Z	1800x800x1000
K8DWR16Z	1600x800x1000
K8DWR14Z	1400x800x1000
K8DWR12Z	1200x800x1000



Double Wave Desking

K8DWD18Z	1800x800x1000
K8DWD16Z	1600x800x1000



Right Hand - Universal Workstations

KUWS18RZ	1800x800x600x1200
KUWS16RZ	1600x800x600x1200
KUWS14RZ	1400x800x600x1200



Left Hand - Universal Workstations

KUWS18LZ	1800x800x600x1200
KUWS16LZ	1600x800x600x1200
KUWS14LZ	1400x800x600x1200



Symmetrical Workstations

KUWS188S	1800x800x800x1800
KUWS168S	1600x800x800x1600
KUWS148S	1400x800x800x1400
KUWS128S	1200x800x800x1200



Rectangular Fabric Screens

380mm high aluminium frame, includes integral toolbar

VSDF184	1800mm
VSDF164	1600mm
VSDF144	1400mm
VSDF124	1200mm
VSDF104	1000mm
VSDF084	800mm



Wave Fabric Screens

380/180mm high aluminium frame, includes integral toolbar

VSDF184W	1800mm
VSDF164W	1600mm
VSDF144W	1400mm
VSDF124W	1200mm
VSDF104W	1000mm
VSDF084W	800mm



Cable Tray

8CT18	1800mm desk
8CT16	1600mm desk
8CT14	1400mm desk
8CT12	1200mm desk
8CT10	1000mm desk
8CT08	800mm desk

Cable Spine

BCRB	Black
BCRS	Silver
BCRW	White

EX10

Executive Desking

- A modern executive style panel ended desk collection offering stylish looks and traditional standards
- Available in a variety of desk & workstation footprints
- 25mm thick MFC top panel, 25mm MFC panel ends with overall height of 738mm
- Delivered and installed fully assembled
- Full depth modesty panel available (subject to £30 surcharge). Suffix code with - FD
- 36mm Top available - add £130 per Top

800mm Deep Rectangular Desking

Can be used with fixed, under desk, tall under desk, or desk high pedestals *Cannot accept fixed pedestals

KNPD18Z	1800x800
KNPD16Z	1600x800
KNPD14Z	1400x800
KNPD12Z	1200x800
KNPD10Z	1000x800
KNPD08Z	800x800



Left Hand Wave Desking

Can be used with fixed, tall under desk, under desk or desk high pedestals

KNPDWL18Z	1800x800x1000
KNPDWL16Z	1600x800x1000
KNPDWL14Z	1400x800x1000



Right Hand Wave Desking

Can be used with fixed, tall under desk, under desk or desk high pedestals

KNPDWR18Z	1800x800x1000
KNPDWR16Z	1600x800x1000
KNPDWR14Z	1400x800x1000



Right Hand Universal Workstations

Can be used with fixed, tall under desk, under desk or desk high pedestals

KNPUWS18RZ	1800x800x600x1200
KNPUWS16RZ	1600x800x600x1200
KNPUWS14RZ	1400x800x600x1200



Left Hand - Universal Workstations

Can be used with fixed, tall under desk, under desk or desk high pedestals

KNPUWS14LZ	1400x800x600x1200
KNPUWS16LZ	1600x800x600x1200
KNPUWS18LZ	1800x800x600x1200



Kidney Desk

Can be used with fixed, tall under desk, under desk or desk high pedestals

KNPDK22Z	2200x800
KNPDK20Z	2000x800
KNPDK18Z	1800x800

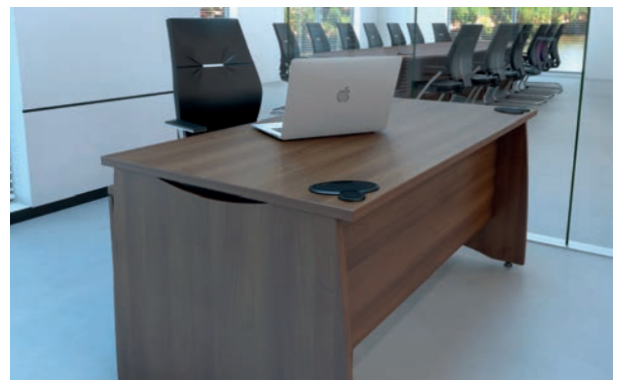



Bow Front Desk

Can be used with fixed, tall under desk, under desk or desk high pedestals

KNPDB20Z	2000x1000x800
KNPDB18Z	1800x1000x800
KNPDB16Z	1600x1000x800



Left Hand Bow Front Workstations

Can be used with fixed, tall under desk, under desk or desk high pedestals

KNPBWS20LZ	2000x800x600x1200
KNPBWS18LZ	1800x800x600x1200
KNPBWS16LZ	1600x800x600x1200



Right Hand Bow Front Workstations

Can be used with fixed, tall under desk, under desk or desk high pedestals

KNPBWS20RZ	2000x800x600x1200
KNPBWS18RZ	1800x800x600x1200
KNPBWS16RZ	1600x800x600x1200



Left Hand Consult Workstation

Can be used with tall under desk, under desk or desk high pedestals on 600mm side only

KNPCWS22LZ	2200x800x600x1200
KNPCWS20LZ	2000x800x600x1200
KNPCWS18LZ	1800x800x600x1200



Right Hand Consult Workstation

Can be used with tall under desk, under desk or desk high pedestals on 600mm side only

KNPCWS22RZ	2200x800x600x1200
KNPCWS20RZ	2000x800x600x1200
KNPCWS18RZ	1800x800x600x1200



BENCHKIT



Cost effective solution for stand-alone applications

- Accepts optional cable trays • Desk top accessories fit through cable ports
- Supplied with integral modesty panels • Delivered and installed fully assembled



800mm Deep Rectangular Desking

BK188	1800x800
BK168	1600x800
BK148	1400x800
BK128	1200x800
BK108	1000x800
BK088	800x800



Left Hand Wave Desking

BKWL18Z	1800x800x1000
BKWL16Z	1600x800x1000
BKWL14Z	1400x800x1000
BKWL12Z	1200x800x1000



Right Hand Wave Desking

BKWR18Z	1800x800x1000
BKWR16Z	1600x800x1000
BKWR14Z	1400x800x1000
BKWR12Z	1200x800x1000



Double Wave Desking

BKDW188Z	1800x800x1000
BKDW168Z	1600x800x1000



Under Desk Pedestal

2 Drawer	2DM	430x600x555
3 Drawer	3DM	430x600x555



Tall Under Desk Pedestal

3 Drawer	3PUM	430x600x625
----------	------	-------------



Tall Under Desk Slimline Pedestal

3 Drawer	3SPUS	340x600x625
----------	-------	-------------



600mm Desk High Pedestal

2 Drawer	2D6S	430x600x727
3 Drawer	3D6S	430x600x727



600mm Desk High - Flyover Top Pedestal

3 Drawer	3D68S	430x800x727
----------	-------	-------------



RISE Electric and Manual



- Height range 680 to 930mm.
- Manually adjustable using retractable handle.
- Available in rectangular & wave footprints.
- Accepts horizontal cable management.

From compact forms to larger spans, Rise can be used independently or positioned in clusters, giving both individuals or teams the ability to fine-tune their levels
Height range 635 to 1290mm. 2 year electrical motor warranty.

Switching between sitting and standing postures throughout the day can help reduce the physical stresses on your body, keep you active at work, and improve your productivity.

Research suggests that we should be standing for at least two hours, gradually increasing that up to four. With a standing desk you can make this change as simple as possible.

Rectangular Desks

HDS18	1800x800
HDS16	1600x800
HDS14	1400x800
HDS12	1200x800
HDS10	1000x800
HDS08	800x800



Right Hand Wave

HDWR18	1800x800x1000
HDWR16	1600x800x1000
HDWR14	1400x800x1000
HDWR12	1200x800x1000



Left Hand Wave

HDWL18	1800x800x1000
HDWL16	1600x800x1000
HDWL14	1400x800x1000
HDWL12	1200x800x1000



Rectangular



Left Hand Wave

FIVE YEAR
MOTOR/MOVING
PARTS GUARANTEE

TEN YEAR
STRUCTURAL
GUARANTEE

RISE SQUARED Sit/Stand Desking



Rise Squared desks are a versatile sit/stand option featuring scalloped tops for easy cable management and integral cable control.

An optional end frame infill panel maintains a sleek aesthetic while doubling as a cable riser. Designed to accept desk top accessories and available with a selection of control panels. Rise desking makes sharing back to back components simple.

Rise Squared Desking

HBS2016	2000x 1600
HBS1816	1800 x 1600
HBS1616	1600 x 1600
HBS1416	1400 x 1600
HBS1216	1200 x 1600

Fabric

VSG2014	2000 x 1400
VSG1814	1800 x 1400
VSG1614	1600 x 1400
VSG1414	1400 x 1400
VSG1214	1200 x 1400

Fabric Separator Screen 200x400
Part glazed - fabric/acrylic (frosted or clear)

VSAG2014	2000 x 1400
VSAG1814	1800 x 1400
VSAG1614	1600 x 1400
VSAG1414	1400 x 1400
VSAG1214	1200 x 1400

Acrylic Separator Screen 200x400

Endframe Infill Panel

Fits between legs and can be used as riser

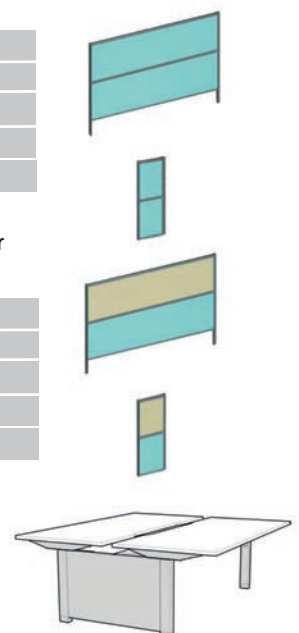
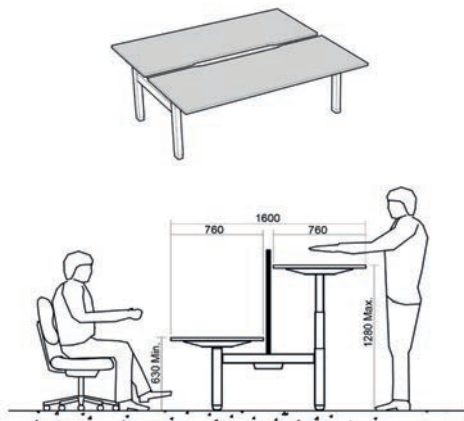



Sit/Stand Tables

- Simple one handed control panel with up and down functions for height adjustment
- Can be moved and nested
- Control panel positioned at end of beam for ease of use

Height Range 635-1290mm providing sit/stand capacity which is easily adjusted via a user friendly touch pad

Sit / Stand Tables

GC1A1	2000 x 1000
GC1A2	1800 x 1000
GC1A3	1600 x 1000
GC1A4	1400 x 1000
GC1B1	2000 x 800
GC1B2	1800 x 800
GC1B3	1600 x 800
GC1B4	1400 x 800

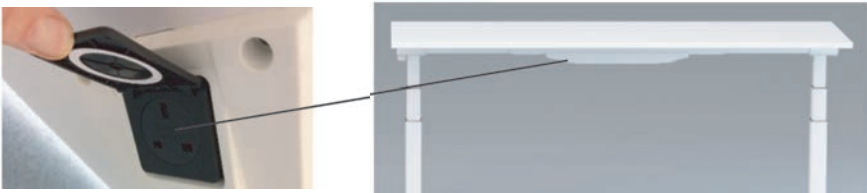

2 UK sockets accessible on the underside of the table.



To add 2 uk sockets add £79.00 to above table prices

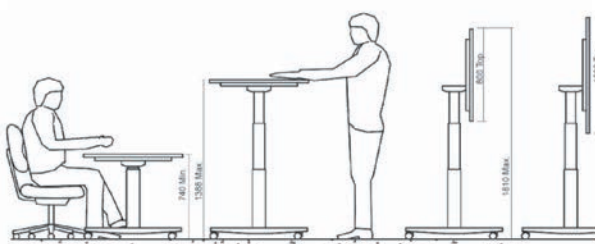

QUICKSTAND



FIVE YEAR WARRANTY



Active working is now an option for everyone. With Humanscale's easy-install QuickStand sit and stand workstation, any desk can easily function as an adjustable-height desk. The key to integrating movement into the work day is simplicity. QuickStand is not only easy to install but easy to use and comes with all you need to get moving right away.



- QSEWS** single monitor
- QSEWD** double monitor
- Laptop Tray**

FLOAT



Float is a height-adjustable sit-stand table that offers more height adjustability, a greater weight accommodation range, and more work surface options than any other counterbalance table.

All come with clean architectural lines that belie it's sophisticated functionality.

- 1600 x 600w
- 1600 x 800w
- 1800 x 800w

FLOAT table shown with M8 Twin Monitor Arm (page 39) and WORLD chair with fabric seat and adjustable arms.



**FIVE
YEAR
WARRANTY**

QUICKSTAND LITE



The Red Dot Award-winning QuickStand Lite transforms any fixed-height desk into an active one. Its minimalist aesthetic complements any office environment and supports a variety of hardware. An adjustable keyboard and monitor arm platform provides exceptional stability while typing. An innovative counterbalance mechanism enables users to transition from sitting to standing positions with ease and encourages more movement – creating a truly active workspace.



reddot award 2016
best of the best

QuickStand Lite

MONITOR ARMS



M2

All the benefits of a traditional dynamic monitor arm - and no shortcomings. The M2 uses an innovative mechanical spring to achieve performance and durability in a lightweight, ultra-thin design.

**TEN
YEAR
WARRANTY**

MON2 Single monitor arm

M8

The perfect fusion of style and strength. Through its unique design, the M8 monitor arm accommodates the widest range of monitors available today, up to 18kg (40 lbs). Combining rugged performance with sleek, handsome aesthetics, the M8 is perfect for heavy monitor applications or any other environment with a flat panel monitor.

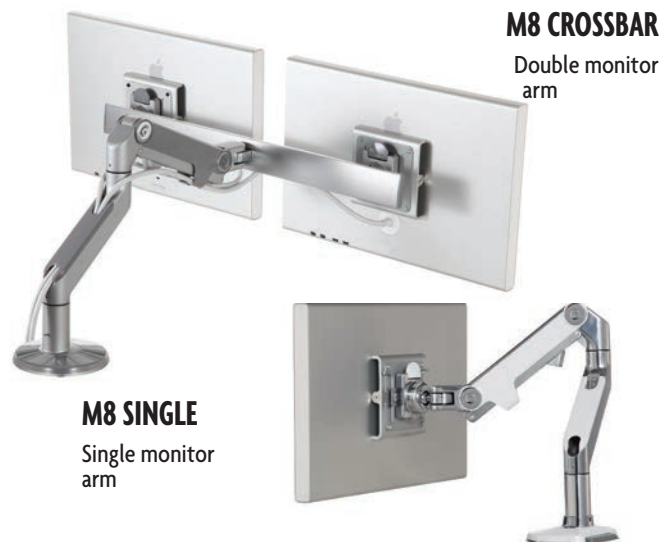

M8 SINGLE
Single monitor arm

M8 CROSSBAR
Double monitor arm

MONITOR ARMS

The BASICS monitor arm provides a sound entry level solution for flat screen monitors.

This basic arm features a VESA standard plate for easy fixing of monitor and has full height adjustment.



2GAMMA

Double gas assisted monitor arm, clamp fitting included. Available in white silver or black.



GAMMA

Single gas assisted monitor arm, clamp fitting included



GLIDEISP

Single pole-mount monitor arm, spring assisted adjustment, clamp fitting included. Available in white, silver, black, green or blue.

HAFSA

Single pole-mount monitor arm, through desk and clamp fitting included. Available in silver, white and black.



2FSA SR

Double pole-mount monitor arm, through desk and clamp fitting included. Available in silver, white and black

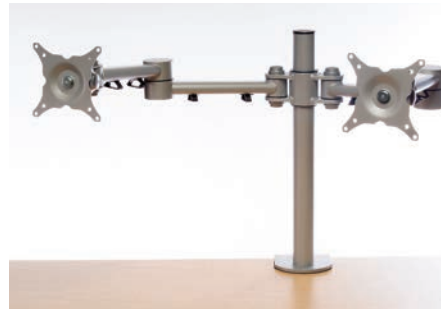

POWER & DATA



KPMW2PINF2D

Flip top Power Module, 2 UK sockets individually fused to 5A
Available in black, silver and white.
Other configurations are available.



PELWIPSC

Porthole Power Module 80mm grommet hole required



DTK2PINF1S

Desk top power module 2x UK sockets individually fused to 5A
Available in black, or white. Other configurations are available.



PMK20

Under desk power module 2x UK sockets individually fused to 5A



PMK40

Under desk power module 4x UK sockets individually fused to 5A



DTK2PINF1S2d

Desk top power module + USB Smartcharge individually fused to 5A
2x DATA Available in black or white.
Other configurations are available.



MLM

For use with all power modules from 1 to 10 mtr

PEDESTALS

Storage

Pedestals are designed to suit all desking ranges and are available as mobile, static or fixed in 600 and 800mm depths



Under Desk	Mobile	Static	
2 Drawer	2DM	2DS	430x600x555
3 Drawer	3DM	3DS	430x600x555



Tall Under Desk			
3 Drawer	3PUM	3PUS	430x600x625



Tall Under Desk Slimline			
3 Drawer	3SPUM	3SPUS	340x600x625



600mm Desk High			
2 Drawer	2D6M	2D6S	430x600x727
3 Drawer	3D6M	3D6S	430x600x727
4 Drawer	4D6M	4D6S	430x600x727



600mm Desk High Slimline			
2 Drawer	2SD6M	2SD6S	340x600x727
3 Drawer	3SD6M	3SD6S	340x600x727
4 Drawer	4SD6M	4SD6S	340x600x727



600mm Desk High - Extended Top (800)			
3 Drawer	3D68M	3D68S	430x800x727



800mm Desk High			
2 Drawer	2D8M	2D8S	430x800x727
3 Drawer	3D8M	3D8S	430x800x727
4 Drawer	4D8M	4D8S	430x800x727



SYSTEM Storage

System storage is available in hinged door, side opening tambour door, and open fronted variations. Each accept a comprehensive range of fitments to suit your storage needs



- Tambour units have integral handles as part of the doors
- Accessories to be ordered separately

Cupboard with Hinged Doors



HD86	950x520x2207
HD79	950x520x2007
HD72	950x520x1837
HD56	950x520x1067
HD48	950x520x1227
HD40	950x520x1007
HD29	950x520x727

Cupboard with Open Front



OF86	950x520x2207
OF79	950x520x2007
OF72	950x520x1837
OF56	950x520x1067
OF48	950x520x1227
OF40	950x520x1007
OF29	950x520x727

Cupboard with Side Opening Tambour



SUST79Z	950x520x2007
SUST72Z	950x520x1837
SUST56Z	950x520x1067
SUST48Z	950x520x1227
SUST40Z	950x520x1007
SUST29Z	950x520x727

Accessories



CSLF
Combi shelf

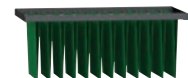

ALFR
Adjustable lateral filing rail



ROSF
Roll out suspension frame



MROS
Metal roll out shelf



ROD
Roll out drawer



AWSZ
Adjustable shelf, 25mm thick MFC



ROSD
Roll our slotted drawer with 5 dividers



AMS
Adjustable shelf, metal



ASM
Adjustable slotted metal shelf with 5 dividers



WHSZ
Wooden hat shelf & coat rail, 25mm thick MFC

MODULAR Storage



Modular Storage is simple shelving units that can be specified as either open fronted or with a combination of lockable doors to suit the users' needs.

- Wooden doors have a suited key system with optional master keys

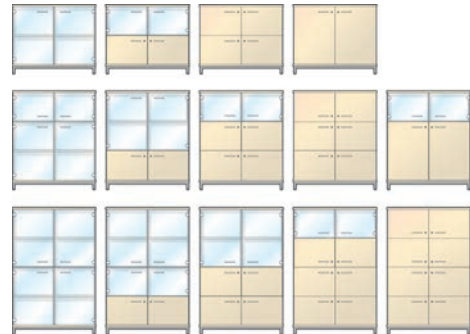

Storage Unit configurations showing alternative door arrangements

Open Fronted Storage

BOF18Z	8 Compartments	1200x400x1816
BOF14Z	6 Compartments	1200x400x1400
BOF10Z	4 Compartments	1200x400x984

Shelf

BAWSZ	Wooden Shelf
-------	--------------

Hinged Locking Wooden Doors

HD4	4 Tier Door Set	1186x18x1660
HD3	3 Tier Door Set	1186x18x1244
HD2	2 Tier Door Set	1186x18x828
HD1	1 Tier Door Set	1186x18x412

Single Locking Post Wooden Door Set - Sold separately

Designed to allow envelopes & small packages to be pushed into cupboard. Recommended that extra wooden shelf be used - see above

HDPR	Right Hand	1186x18x380	£32.00
HDPL	Left Hand	1186x18x380	£32.00

Hinged Non-Locking Frosted Glass Doors - Sold separately

GHD2	2 Tier Door Set	1186x6x828	£205.00
GHD1	1 Tier Door Set	1186x6x412	£150.00

Hinged Non-Locking Clear Glass Doors - Sold separately

GHD2C	2 Tier Door Set	1186x6x828	£205.00
GHD1C	1 Tier Door Set	1186x6x412	£150.00



CABINETS & UNITS

Storage

Filing Cabinets

FC4	4 Drawer	480x600x1352
FC3	3 Drawer	480x800x1037
FC28	2 Drawer Ext Top	480x800x727
FC2	2 Drawer	480x600x727



800mm Wide 2 Drawer Side Filing Units

SFU88	800 Ext Top	800x800x727
SFU86	600mm Ext Top	800x600x727
SFU8	2 Drawer	800x520x727



Desk High Bookcase

Accepts 2 rows of A4 files

SUB16Z	2 Tier	1600x320x727
SUB12Z	2 Tier	1200x320x727
SUB10Z	2 Tier	1000x320x727
SUB08Z	2 Tier	800x320x727
SUB06Z	2 Tier	600x320x727



Open Fronted Bookcase Shelving

Accepts rows of A4/foolscap lever arch & box files.

*B5Z requires wall fixing for stability.

B5Z	5 Tier	800x350x2120
B4Z	4 Tier	800x350x1710
B3Z	3 Tier	800x350x1300
B2Z	2 Tier	800x350x890



BWFB Wall Fixing Brackets

Bookcase Shelving with Locking Doors

Accepts rows of A4/foolscap lever arch & box files.

*Requires wall fixing for stability.

B5DZ*	5 Tier	800x350x2120
B4DZ*	4 Tier	800x350x1710
B3DZ*	3 Tier	800x350x1300
B2DZ*	2 Tier	800x350x890



BWFB Wall Fixing Brackets



VERCO
Intuition

The Intuition desking range reflects the traditional Verco attention to quality and detail. Desk tops are 30mm thick with a reverse chamfer on all edges. Leg frames include height levellers and vertical wire tidying facilities as standard.

A choice of three veneers: Cherry, Maple and Walnut, highlighted with silver fittings, meets the demands of the modern marketplace.

Simplicity and functionality, with the elegant large sweeping work surfaces reflect the gracefulness of this distinctive range.

Tables, pedestals, cupboards and bookcases which suite with the desking, are all available with the same silver finishes to highlight the beauty of the real wood veneers



Rectangular Desk 1900x1000x720mm

Mobile underdesk pedestal 420x600x640mm

Low Storage unit 1000x535x815mm

Bookcase with glass doors 1000x350x785mm

Meeting Tables

Round 1200 Diameter
Mix Chairs

D End 2500x1200x720mm 8 person
Danny Chairs Swivel Tub



Crescent Desk

Left or Right Hand 1900x1240x720mm
Crescent Return 1150x770x720mm

Rectangular Desk 1900x1000x720mm
Scalloped Meeting End 1000x787x720mm
Bookcase Frosted Glass 1000x350x785mm

Storage

Tall two door storage 1000x535x1600mm
Low Side Filer 1000x535x815mm

VERCO
Corniche

The Corniche desking range represents a commitment to providing a range of executive furniture with the highest achievable standards of elegance and quality. Desk tops are 40mm thick with solid wood lippings all round and with Bull nose profiles on the front and rear edges.

A choice of three veneers: Oak, Cherry and Maple and the additional ability to stain to sample ensures that Corniche will enhance any office environment.

High quality materials, craftsmanship and close attention to detail is typical of the range and is exemplified by the solid sculptured wooden pen tray which is available for all Corniche pedestals.

Conference tables and ends, mobile or desk height pedestals, cupboards and bookcases which suite with the desking, are available to meet all requirements.



Panel Ended desks 2000x1000x720mm

Panel Ended desks 1800x800x720

Mobile under desk pedestal 420x600x675mm

Bow Fronted Panel End desk
2000x1000/800x720mm



Meeting Tables

- 2500x1100x720mm (8 Person)
- 3000x1100x720mm (10 Person)
- 4000x1100x720mm (12 Person)



Desk Return 1020x610x720mm

Teardrop Conference End
920x1020x720mm

Glass fronted Book Case
1000x330x920mm

Storage

Single Low two door Storage unit
1000x535x815mm

Tall two door Storage unit
1000x535x600mm
Shelves for storage

FILING

Filing Cabinet Features

- Drawers run on smooth ball-bearing slides with a positive door close
- Hardwearing textured paint finish
- Fully extending drawers for easy access to contents
- Robust fully welded carcass
- Anti-tilt safety device
- Locking
- Available in Goose Grey
- 5 year guarantee



FCAB2	2 Drawer filing cabinet	470x622x711mm
FCAB3	3 Drawer filing cabinet	470x622x1016mm
FCAB4	4 Drawer filing cabinet	470x622x1321mm

Stationery Cupboard Features

- Attractive hardwearing textured paint finish
- Robust fully welded carcass
- Dual purpose shelves to accommodate under shelf filing
- 3 point locking mechanism for added security
- Cupboards supplied complete with shelves



E40A01	2 door stationery cupboard	1000h 1 Shelf
E72A03	2 door stationery cupboard	1800h 3 Shelves
E702A04	2 Door cupboard	1980h 4 Shelves
E198P1	Additional dual purpose shelf - black	

Bisley Cupboards

Essentials cupboards are aesthetically similar to Bisley A-Series 2 door cupboards



800mm wide 914mm wide 1000mm wide

YECB010	Cupboard + 1 shelf	1000 - 1015h
YECB011	Cupboard + 1 shelf	1070 - 1085h
YECB012	Cupboard + 2 shelves	1270 - 1285h
YECB015	Cupboard + 3 shelves	1570 - 1585h
YECB019	Cupboard + 4 shelves	1970 - 1985h

- Cupboards come in 5 heights with adjustable levelling feet providing 15mm adjustment
- Available in 3 widths - 800, 914 & 1000mm
- 1070mm cupboards have been designed to meet standing height standards

Bisley Lodges

Personal storage units have been designed to suit most Essentials products



800mm wide 1000mm wide

YELD07	Lodge 2x10.5" & 2x12" Doors	693-708h
YELD010	Lodge 4x10.5" & 2x12" Doors	1000-1051h
YELD012	Lodge 8x10.5" Doors	1270-1285h
YELD013	Lodge 6x10.5" & 2x12" Doors	1300-1315h

- Essentials Lodges come in 4 heights matching drawer unit dimensions
- Available in 2 widths - 800 and 1000mm
- 4, 6 and 8 door options are available
- 693, 1000 and 1300mm will include 12" bottom doors

TAMBOURS

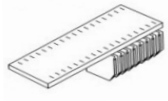

YEC3

Cupboard shelf with under filing shelf
for 800,914 and 1000 units

MSDIV

Dividers (5 pack)

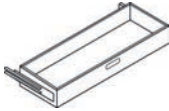

RODWR4

Roll Out Drawer 1000w



ROS-1

Roll out shelf 1000w

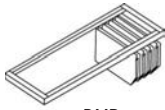

BUR

Lateral filing rail 1000w

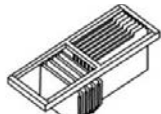

ROSFF

Roll out filing frame A4 and
Foolscap 1000w



Carcass Colour

White

Silver

Anthracite

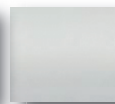
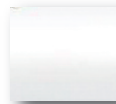

Shutter Colours

Silver

Grey

Black

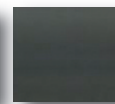
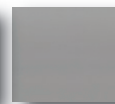
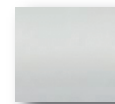

Tambours Features

- Accepts A4/Foolscap suspension filing
- Lateral filing available
- Full range of accessories available
- Locking
- 5 year guarantee

Everyday Bisley Tambours - grey only

CST40	Tambour 1000 - 1015h
CST65	Tambour 1570 - 1585h
CST78	Tambour 1970 - 1985h
BSS	Shelves

Bisley Essential Tambours

800mm wide 1000mm wide

YETB10	Tambour + 1 shelf 1000 - 1015h
YETB11	Tambour + 1 shelf 1070 - 1085h
YETB12	Tambour + 2 shelves 1270 - 1285h
YETB15	Tambour + 3 shelves 1570 - 1585h
YETB19	Tambour + 4 shelves 1970 - 1985h
YETB22	Tambour + 5 shelves 2270 - 2285h

**FIVE
YEAR
WARRANTY**

Lockers that can stand up to heavy use whilst looking stylish - **SHOCKPROOF LOCKERS** fitted with 10mm Solid Grade Laminate doors. The solid grade laminate door material from Formica, Trespa, Arpa and Polyrey are designed to offer a strong and resilient door that can withstand knocks and scrapes that may leave other lockers with dents and scratches. Impact Resistant • Scratch Resistant • Graffiti Resistant • Wear Resistant • Moisture Resistant • Easy Clean



Our range of high quality powder coated steel lockers achieve the rare distinction of being tested as non-combustible and approved in line with the European Standard - EN 13501-1: 2007 +A1: 2009 relating to fire performance. These lockers will not combust, increase or sustain any fire within their proximity. Available in a wide range of door colour, door tier and lock options.

ALL STEEL LOCKERS WITH STANDARD COLOURS

Locker size: 1780x305x305

Code No of doors

701212	single
701212/2	2
701212/3	3
701212/4	4
701212/5	5
701212/6	6
701212/8	8
701212/16	16



STEEL CARCASS WITH LAMINATE DOORS

Locker size: 1780x305x390

Code Doors

LAM1215/1PO	1
LAM1215/2PO	2
LAM1215/3PO	3
LAM1215/4PO	4



ALL STEEL WITH AUTUMN COLOURS

Locker size: 1780x305x305

Code Doors

A701212	single
A701212/2	2
A701212/3	3
A701212/4	4
A701212/5	5
A701212/6	6



ALL STEEL LOCKERS WITH STANDARD COLOURS

Code Description Doors Locker Size

701818 C/D	Clean & Dirty	1	1780 x 460 x 460
701855 PO	Police	1	1780 x 460 x 550

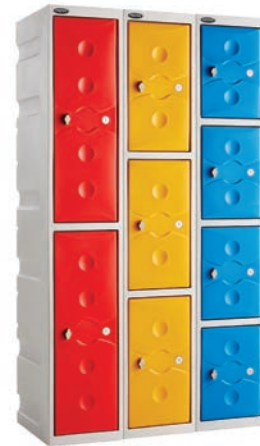

PLASTIC LOCKERS

Locker size: 1800x325x450

Code Doors

PL/180/325/450/2	2
SH-PL/180/325/450/3	3
SH-PL/180/325/450/4	4

LOCK OPTIONS



TYPE L
Electronic Digital

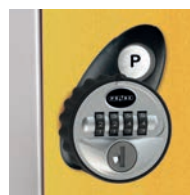

TYPE P
Combination



TYPE A
Key Operated Cam
STANDARD



TYPE B
Hasp for Padlock
NO COST OPTION

Master Key for type A

Master Key for type L

Master Key for type P

EVERYDAY ROLLED EDGE SHELVING

Starter and Extension bays

Finished in light grey they come complete with all necessary fittings.

The bays are supplied with six shelves and the relevant rear bracing or cladding



Fully cladded

EV18/10/30/C/ST	1830 x 1000x300mm Clad Back c/w 6 shelves	Starter
EV18/10/30/C/EX	1830 x 1000x300mm Clad Back c/w 6 shelves	Add on
EV18/10/45/C/ST	1830 x 1000x450mm Clad Back c/w 6 shelves	Starter
EV18/10/45/C/EX	1830 x 1000x450mm Clad Back c/w 6 shelves	Add on



Cross braced

EV18/10/30/O/ST	1830 x 1000x300mm Braced c/w 6 shelves	Starter
EV18/10/30/O/EX	1830 x 1000x300mm Braced c/w 6 shelves	Add on
EV18/10/45/O/ST	1830 x 1000x450mm Braced c/w 6 shelves	Starter
EV18/10/45/O/EX	1830 x 1000x450mm Braced c/w 6 shelves	Add on

Library Shelving Single Sided

TS/1825/ST/5	1800x900x250mm C/W 5 shelves + canopy	Starter
TS/1825/EX/5	1800x900x250mm C/W 5 shelves + canopy	Starter



Library Shelving Double Sided

TS/1825/ST/5	1800x900x250mm C/W 5 shelves + canopy per side	Starter
TS/1825/EX/5	1800x900x250mm C/W 5 shelves + canopy per side	Add on



Typical Mobile/Rolling shelving Installation

Based on 20 Bays 1830mm high x 1000mm wide x 300mm deep with 6 shelves

Typical price £7228.00 installed (subject to site survey)

Steel Décor end panels to handwheel ends extra





CIRCO

Circo is a functionally simple light work conference and task chair with a permanently floating action and a mesh back that morphs to support the user.

These features are equally welcome in conference and meeting room environments where conventional static seating may not provide adequate movement to promote healthy sitting.



CR4
Conference chair, dynamic
yoke with glides



CR2
Conference chair, dynamic
yoke with castors

PRICED IN BAND 1 FABRIC



AD-LIB

The role of multi-purpose seating has become increasingly important. Ad-Lib has been designed to provide diversity of scope, without compromising cost, performance or build.

Its modular single-core structure centres upon a frame that accommodates different panels as seating surfaces. These optimise both seating comfort and build for each need and environment.

The core frame supports six different structures, which can be fitted with or without arms.



ADL7
Upholstered seat and back,
black frame (Add for chrome)



ADL7A
Upholstered seat and back
with arms, black frame (Add for
chrome)



ADL12
Upholstered seat with mesh
back, black frame (Add for
chrome)



ADL12A
Upholstered seat with mesh
back and arms, black frame (Add for
chrome)



ADL10
Upholstered seat and
back with castors



ADL10A
Upholstered seat and back
with arms and castors



ADL15
Upholstered seat with
mesh back and castors



ADL15A
Upholstered seat with mesh
back, castors and arms

PRICED IN BAND 1 FABRIC

**FIVE
YEAR
WARRANTY**

TRILLIPSE

Trillipse is the original multi-purpose chair family. The four leg stacking upholstered chair, developed as a general purpose meeting chair for the work place and educational environment, is the basis of the range and as such also includes a host of options to enhance its versatility.



T114A
Fixed arms,
upholstered seat and
back



T114
Upholstered seat and
back



T104A
Fixed arms, upholstered
seat and plastic back



T104
Upholstered seat
and plastic back

PRICED IN BAND 1 FABRIC

HEAVY DUTY Seating



110C
4 Leg chair with curved
front legs (stackable)



110SWT
4 Leg chair with swivel writing
tablet (fits either side) (stackable)



120SM
4 Leg chair with moulded
arm (stackable)



210S
4 Leg chair (stackable)



220M
4 Leg chair with
moulded arms



230
Cantilever chair



240M
Cantilever chair with arms



310S
4 Leg chair (stackable)



340M
Cantilever chair with
moulded arms



CEN Visitor chairs

Simple yet classic – elegant and comfortable, this comprehensive range of meeting room chairs combining style and versatility make the perfect addition to any meeting or conference environment.

Choose between the more conventional upholstered version on a cantilever frame or the mesh back version with a cantilever frame or four star base.



CENMESH P
Pedestal chair



CENMESH C
Cantilever chair



CEN700VC
Chrome Frame cantilever
Armchair



CEN800V
Chrome frame cantilever
Armchair

CEN700VS
Silver Frame cantilever Armchair

**FIVE
YEAR**
WARRANTY



ARRAY

Array is a simple yet functional high density stacking chair offering space saving advantages and flexibility to any environment. Ideal for conference, education, meeting or cafeteria environments.



ARY1

Upholstered seat
with plastic back



ARY0

Plastic seat and back

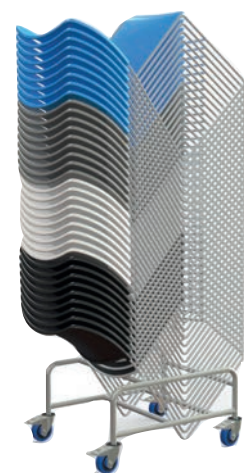

ARYTROLL

Trolley

Seat and back colours
available:

White, Light Grey, Black, Blue,

KYOS



KS2
KYOS upholstered seat
with plastic back



KS2A
KYOS upholstered
seat, plastic back with
arms



KS5
KYOS upholstered seat
with plastic back



KS5A
KYOS upholstered
seat, plastic back with
arms



KS3
KYOS upholstered
seat and back



KS3A
KYOS upholstered seat
and back with arms



KM8
KYOS upholstered
seat with mesh back



KM8A
KYOS upholstered seat
with mesh back and arms

Kyos is a stylish and versatile multi purpose chair ideal for government, corporate and public sector environments. It is available with two frame options; four leg or cantilever, all of which come with or without arms.

**FIVE
YEAR**
WARRANTY

CALL FOR
FREE
COLOUR
SWATCHES

ELIOS



HD405A
Plastic seat and back
with arm



HD405
Plastic seat and back



HD410A
Fabric seat, plastic back with arm



HD410
Fabric seat, plastic back



HD415A
Fabric seat and back with arm



HD415
Fabric seat and back

The Elios high density stacking chair is available with or without arms and with a host of accessories. Perfect for large scale conferencing or general multi-purpose use.

PRICED IN BAND 1 FABRIC



CHIPPER

Chipper is everything in one: stacking chair, arm chair, upholstered chair, rows of linked chairs. Different options and accessories make Chipper truly versatile and vibrant. Options include upholstered pads, arms, glides and linking accessories.

The range also includes a bar stool and a chair dolly.



CHP40
Plastic seat and back



CHP40A
Plastic seat and back with arms



CHP42
Upholstered seat and back



CHPB0
Bar stool with plastic seat and back



CHPR2
Upholstered seat and back with sledge base



CHPR1
Upholstered seat with plastic back and sledge base



CHPROA
Plastic seat and back with sledge base



Seat and back colours available:

White, Grey, Black, Blue, Green, Red, Brown

CHDOL
Dolly

ZELA

Zela multi-purpose seating lends itself perfectly to large scale conferencing, meeting rooms and single use application.

Features and options

Unique design

Robust structure and elegant lines will compliment any environment.

Available in eight plastic colours.

Dual linking/vertical stacking feature

Seat and back colours available:

White, Grey, Black, Blue, Green, Red, Orange, Cream



ZL1
4 Leg



ZLA
4 Leg with arms



**ZLART (RH)
ZLALT (LH)**
4 Leg with arms and writing tablet



Stacking aid



ZL1SP
4 Leg



ZLASP
4 Leg with arms



**ZLARTSP (RH)
ZLALTSP (LH)**
4 Leg with arms and writing tablet



Dual link and stacking feature



ZL1BP
4 Leg



ZLABP
4 Leg with arms



**ZLARTBP (RH)
ZLALTBP (LH)**
4 Leg with arms and writing tablet

PRICED IN BAND 1 FABRIC



MOLLIE



A681
Dining chair, pedestal base



A584
High stool, height adjustable



A583
High stool, 4 leg



A680
Dining chair 4 leg

Our new variants of this popular chair retain the classic silhouette of the original design whilst featuring a deeper, fuller back support and a slightly more generous seat width. A luxurious and satisfying design, Mollie is suited to hotel and restaurant dining, bars or corporate environments.

PRICED IN BAND 1 FABRIC

TOMMO



The contemporary and intelligent design of the Tommo range places it easily in a host of spaces within corporate and hospitality environments. The fully upholstered chair features slender upholstery styling and twin stitch seam detail, complemented by a light and elegant tubular skid base.



A532Q
Dining chair, low arm

PRICED IN BAND 1 FABRIC

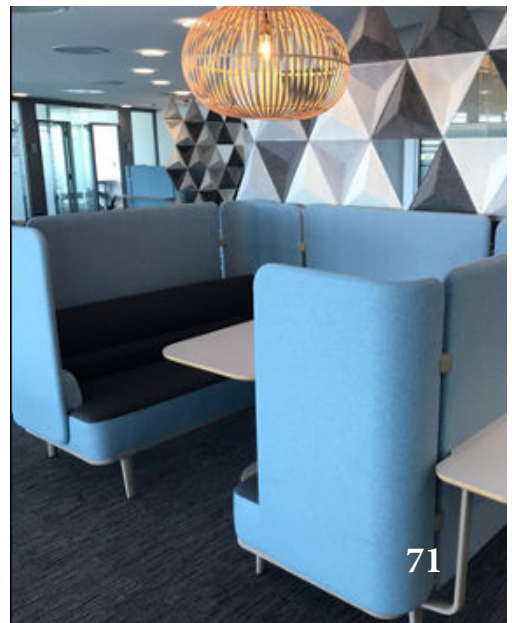
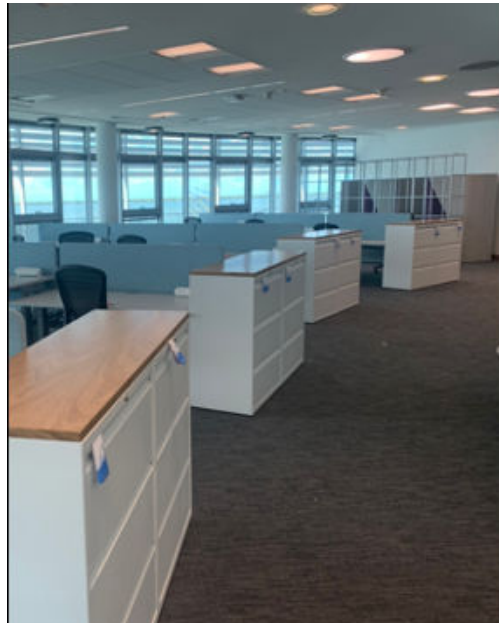

CASPER

Casper's distinctive angular faceted upper backrest blends down into the curvaceous seat in a unique way while the equally distinctive slot in the lower back, relieves the volume of the chair aesthetically. Casper provides a relaxing, supportive, comfortable sit with both flex and support in equal measure.



CS2
Casper side chair with 4 leg frame



CS2A
Casper armchair with 4 leg frame



CS4
Casper side chair with 4 leg
frame & upholstered seat



CS4A
Casper armchair with 4 leg
frame & upholstered seat

Shell colours available:

White, Slate Grey, Smoke
Grey, Black, Blue, Red

ARLO

The stacking chair design seeks to embrace the technological possibilities of structural injection moulded plastics to reinvent the ubiquitous steel cantilever chair. The concept delivers a flexing organic form that provides true ergonomic comfort and support to its user.



783

Plastic seat and
back - stackable



784

Upholstered seat -
stackable





EG04NSP



EG04WSP
4 Leg American Walnut



EG05NSP
4 Leg natural satin
with upholstered seat
and fully welded
frame (stackable)



EG05WSP
4 Leg American walnut
with upholstered seat
and fully welded frame
(stackable)



EGS8N



EGS8W



EGS8NSP



EGS8WSP

EGIS

The Egis family offers single-piece laminated shell chairs available in four distinct profiles. With or without upholstered seat pads and in two finish colours. Selected items within this range are stackable.



EG01N
4 Leg natural satin
(stackable)



EG01W
4 Leg American walnut
(stackable)



EG02N
4 Leg natural satin
(stackable)



EG02W
4 Leg American walnut
(stackable)



EG04NSP
4 Leg natural satin
(stackable)



EG04WSP
4 Leg American walnut
(stackable)



EG05NSP
4 Leg natural satin
with fully welded
frame (stackable)



EG05W
4 Leg American walnut
with fully welded
frame (stackable)



EG01NSP
4 Leg natural satin
upholstered seat
(stackable)



EG01WSP
4 Leg American walnut
upholstered seat
(stackable)



EG02NSP
4 Leg natural satin
upholstered seat
(stackable)



EG02WSP
4 Leg American walnut
upholstered seat
(stackable)

MATA

Fresh, fun and modern, the Mata range is superbly engineered for strength and durability. Its 'S' shaped memory back provides excellent support and flexibility for all ages.

Mata is equally at home in the office, classroom or breakout areas and is available in 8 standard colours and in a range of formats and sizes.





SL6
Skid Base Chair



SM6L
Standard Chair



S62
Mata High Sled 620mm
high H1020 W580 D580
SH620mm
MATA/SLSTOOL/S/62



SM6S
Swivel Gas Lift Chair



ST6
4 Leg Stool
(chrome frame only)



SM6C
Reverse Cantilever
Chair



- Moulded polypropylene shell
- Fully welded frame
- BS 4875: Part 1: 2001 Test Level 4 (strength and durability)
- BS 7945: 1999 (stability)
- BS EN 1729 (sizing standards)
- Manufactured in the UK

Mata 4 leg is available in six EN 1729 sizes

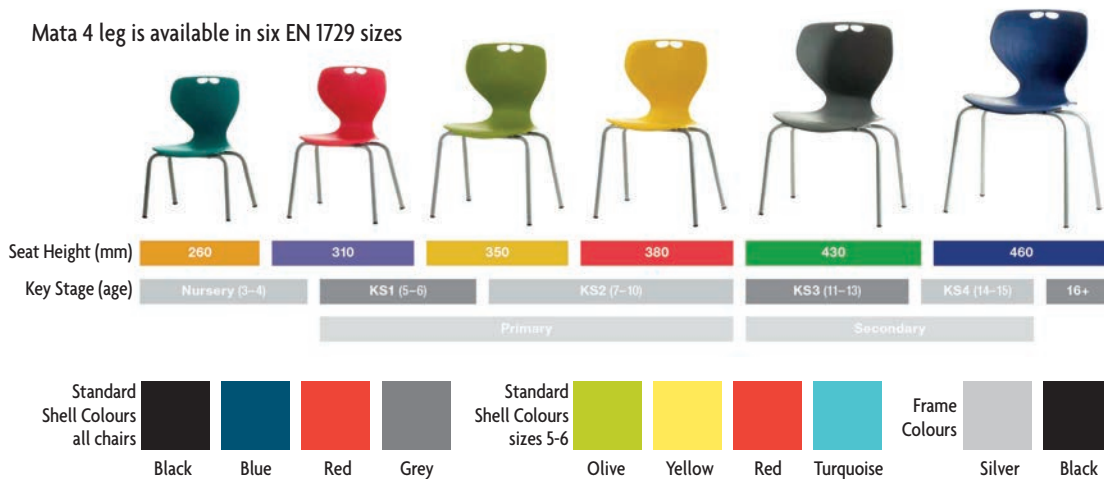

MULTI-PURPOSE STC Tables

A range of multi-purpose tables with fully-welded steel frames that combine simplicity with strength and stability.

- Available in a selection of footprints.
- Rectangular tables can be spirally stacked.
- 25mm MFC top panels.



Rectangular 800mm Deep

STC188Z	1800 x 800
STC168Z	1600 x 800
STC148Z	1400 x 800
STC138Z	1300 x 800
STC128Z	1200 x 800
STC108Z	1000 x 800
STC088Z	800 x 800



Trapezium

TT188Z	1800 x 800 x 1000
TT168Z	1600 x 800 x 800
TT147Z	1400 x 700 x 700
TT128Z	1200 x 800 x 400
TT126Z	1200 x 600 x 600



Rectangular 700mm Deep

STC187Z	1800 x 700
STC167Z	1600 x 700
STC147Z	1400 x 700
STC137Z	1300 x 700
STC127Z	1200 x 700
STC107Z	1000 x 700
STC087Z	800 x 700
STC077Z	700 x 700



Semi-Circular

SCT18Z	1800 x 900
SCT16Z	1600 x 800
SCT14Z	1400 x 700
SCT12Z	1200 x 600



Rectangular 600mm Deep

STC186Z	1800 x 600
STC166Z	1600 x 600
STC146Z	1400 x 600
STC136Z	1300 x 600
STC126Z	1200 x 600
STC106Z	1000 x 600
STC086Z	800 x 600
STC066Z	600 x 600



Circular

FTC16Z	1600
FTC14Z	1400
FTC12Z	1200
FTC10Z	1000
FTC08Z	800





LTA Tables
Black cross base



LTF Tables
Flat black base



LTD Tables
Chrome trumpet base



LTC Tables
Chrome cross base

Coffee - 455mm High

Group Z 25mm MFC

LTA LTF LTD LTC

LT*06CR	Circular	ø600
LT*66R	Square	600 x 600

Lounge - 575mm High

Group Z 25mm MFC

LTA LTF LTD LTC

LT*10CL	Circular	ø1000	£	£267.00
LT*09CL	Circular	ø900		
LT*08CL	Circular	ø800		
LT*07CL	Circular	ø700		
LT*06CL	Circular	ø600		

LT*88L	Square	800 x 800
LT*77L	Square	700 x 700
LT*66L	Square	600 x 600

Dining - 745mm High

Group Z 25mm MFC

LTA LTF LTD LTC

LT*10CD	Circular	ø1000
LT*09CD	Circular	ø900
LT*08CD	Circular	ø800
LT*07CD	Circular	ø700
LT*06CD	Circular	ø600

LT*88D	Square	800 x 800
LT*77D	Square	700 x 700
LT*66D	Square	600 x 600

Twin Pedestal Dining - 745mm High

Group Z 25mm MFC

LTA LTF LTD LTC

LT*148D	Rectangular	1400 x 800	N/A
LT*147D	Rectangular	1400 x 700	N/A
LT*128D	Rectangular	1200 x 800	N/A
LT*127D	Rectangular	1200 x 700	N/A

Mid Poseur - 950mm High

Group Z 25mm MFC

LTA LTF LTD LTC

LT*66MP	Square	600 x 600
LT*06CMP	Circular	ø600

Poseur - 1125mm High

Group Z 25mm MFC

LTA LTF LTD LTC

LT*66P	Square	600 x 600
LT*06CP	Circular	ø600

TRAINING & CONFERENCE



**TEN
YEAR
WARRANTY**



TILT TOP Tables

Robust construction and a simple tilt facility. Fully mobile tables for reconfiguration, stored by a single operator. Available with a choice of silver, chrome or white end frames. Overall height 727mm with 25mm tops.

Rectangular - 700mm White/Silver Frame

DRMT 187Z	1800 x 700
DRMT 167Z	1600 x 700
DRMT 147Z	1400 x 700
DRMT 127Z	1200 x 700
DRMT 107Z	1000 x 700

Rectangular - 800mm

DRMT 188Z	1800 x 800
DRMT 168Z	1600 x 800
DRMT 148Z	1400 x 800
DRMT 128Z	1200 x 800
DRMT 108Z	1000 x 800

Trapezium - 1400mm

DTMT 14Z	1400 x 700 x 700
----------	------------------

Trapezium - 1600mm

DTMT 16Z	1600 x 800 x 800
----------	------------------

Semi-Circular - 1400mm White/Silver Frame

DSMT 14Z	ø1400 x 700
----------	-------------

Semi-Circular - 1600mm

DSMT 16Z	ø1600 x 800
----------	-------------

Circular - 1000mm

DCMT 12Z	ø1200
DCMT 10Z	ø1000

Suspended Modesty Panels - Fits To Appropriate Table Beams

DRCPW 18	1750 x 300
DRCPW 16	1550 x 300
DRCPW 14	1350 x 300
DRCPW 12	1150 x 300

Table Connector Set - Conlink
Chrome frame - add



EVM750
Square table 750 x 750



EVTMT15
trapezoidal table



EVSMT15
Semicircle table 1500w

**FIVE
YEAR
WARRANTY**

EVERYDAY Flip Top Tables

The Everyday collection comprises a series of distinctive modular tables. Each designed to meet a multiplicity of requirements from impromptu meetings to the prestigious conference facility.

The collection can be quickly assembled, rearranged, stacked and stored, saving space and time.

Everyday tables are designed to flip through 90° for easy storage or movement during relocation eg. room-to-room.

STANDARD FEATURES:

QUICK RELEASE FOLDING MECHANISM
WITH AUTO ENGAGEMENT
TUBULAR STEEL FRAME
BLACK 40mm CASTOR WITH
MANUAL BRAKE
25mm MFC TOP



EVPMT15
Rectangular table 1500 x 750



EVPMT18
Rectangular table 1800 x 750



**TEN
YEAR
WARRANTY**

COFFEE Tables

Perfect for casual seating clusters and use as occasional coffee tables. Or choose a table designed to be used with task chairs for more formal situations such as interviews or meetings. Our selection of reception tables are the perfect blend of form and function and will enhance any lobby or reception area.

Fully Welded Bench

BRT106Z	Rectangular	1000x600 x 400
BRT088Z	Square	800 x 800 x 400
BRT066Z	Square	600 x 600 x 400
BRTC08Z	Circular	800 dia
BRTC06Z	Circular	600 dia



Fully Welded - 50mm Diameter Circular Leg

PR106Z	Rectangular	1000 x 600 x 400
PR6Z	Square	600 x 600 x 400
PR7Z	Boat Shaped	1000 x 600 x 400
SAVCTZ	Oval	1000 x 600 x 400
PC8Z	Circular	800 dia
PC6Z	Circular	600 dia



Fully Welded - 25mm Square Leg

STC104Z	Rectangular	1000 x 600 x 400
STC064Z	Square	600 x 600 x 400
STE104Z	Oval	1000 x 600 x 400
FTC084Z	Circular	800 dia
FTC064Z	Circular	600 dia



Clear Glass Top, Chrome Legs

GLAS9S	Rectangular	950 x 500 x 350
GLAS5S	Square	500 x 500 x 350



Frosted Glass Top, Chrome Legs

GLAS9SF	Rectangular	950 x 500 x 350
GLAS5SF	Square	500 x 500 x 350
GLAS6F	Circular	500 dia



ROUNDED CORNER SQUARE TABLE

SCRIPT Tables

This simple but stylish table range features interconnecting underframes that provide strength whilst keeping the users knee space clear.

- Available with angled or straight legged options.
- Available in a large selection of footprints.
- K.D. product that is delivered then installed fully assembled.
- 25mm MFC top panels.

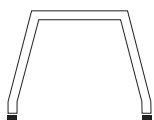

Angled leg

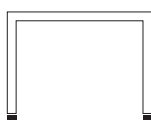

Straight leg

Dining Rectangular

Angled Leg Straight Leg

XTA188	XTS188	1800 x 800
XTA168	XTS168	1600 x 800
XTA148	XTS148	1400 x 800
XTA128	XTS128	1200 x 800
XTA187	XTS187	1800 x 700
XTA167	XTS167	1600 x 700
XTA147	XTS147	1400 x 700
XTA126	XTS127	1200 x 700



Dining Square

XTAS12	XTSS12	1200 x 1200
XTAS10	XTSS10	1000 x 1000
XTAS08	XTSS08	800 x 800
XTAS07	XTSS07	700 x 700
XTAS06	XTSS016	600 x 600



Dining Circular

Angled Leg Square Leg

XTAC16	XTSC16	ø1600
XTAC14	XTSC14	ø1400
XTAC12	XTSC12	ø1200
XTAC10	XTSC10	ø1000
XTAC08	XTSC08	ø800



Dining Lozenge Shaped

XTAL188	XTSL188	1800 x 800
XTAL168	XTSL168	1600 x 800
XTAL148	XTSL148	1400 x 800
XTAL128	XTSL128	1200 x 800



Dining Rounded Corner Square

XTAP12	XTSP12	1200 x 1200
XTAP10	XTSP10	1000 x 1000
XTAP08	XTSP08	800 x 800
XTAP07	XTSP07	700 x 700
XTAP06	XTSP06	600 x 600



Coffee - 455mm High

XRTAC08	XRTSC08	Circular	ø800
XRTAC06	XRTSC06	Circular	ø600
XRTAS06	XRTSS06	Square	600 x 600
XRTA106	XRTS106	Rectangular	1000 x 600
XRTAL106	XRTSL106	Lozenge	1000 x 600
XRTAP06	XRTSP06	RC Square	600 x 600

Lounge - 575mm High

XTAC12L	XTSC12L	Circular	ø1200
XTAC10L	XTSC10L	Circular	ø1000
XTAC08L	XTSC08L	Circular	ø800
XTAS08L	N/A	Square	800 x 800
XTAS07L	N/A	Square	700 x 700
XTAS06L	N/A	Square	600 x 600

BELIEVE Tables

Seating capacities for guidance only and can differ depending on size of chair used.

Large Format Tables - Starter & Add-on Units

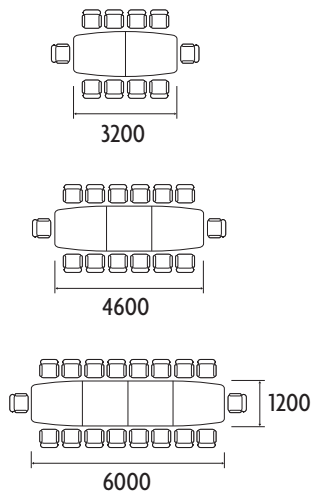

Starter Unit	25mm MFC
PBET16	1600 x 1200

Add-on End	25mm MFC
PBET16A	1600 x 1200

Add-on Centre	25mm MFC
PBCT14A	1400 x 1200

Rectangular	
PTR1810	1800 x 1000
PTR1610	1600 x 1000
PTR1410	1400 x 1000
PTR1808	1800 x 800
PTR1608	1600 x 800
PTR1408	1400 x 800
PTR1208	1200 x 800

Square	
PTR1212	1200 x 1200
PTR1010	1000 x 1000

Circular	
PTC16	ø1600
PTC14	ø1400
PTC12	ø1200

Boat Shaped	
PTR24	2400 x 1000 x 800
PTR22	2200 x 1000 x 800
PTR20	2000 x 1000 x 800
PTR18	1800 x 1000 x 800
PTR16	1600 x 1000 x 800

Lozenge Shaped	
PTL24	2400 x 1000 x 800
PTL22	2200 x 1000 x 800
PTL20	2000 x 1000 x 800

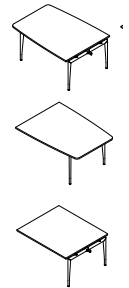

EX10 & X10 Tables



Tables

- Stylish and functional.
- Available in panel ended or metal frame.
- Available in a variety of sizes and footprints.



**X10 Centilever
Frame**
Rectangular,
Boat, Lozenge,
Large Format

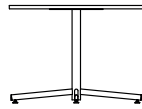

X10 Cross Frame
Circular, Square

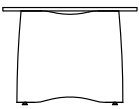

**EX10 Panel End
Frame**
Rectangular,
Boat, Lozenge,
Large Format

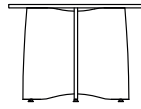

**EX10 Panel Cross
Frame**
Circular, Square,
Oval

Large Format End & Centre Units



Rectangular Panel End

Metal Frame

KNPTR2410	KNTR2410	2400 x 1000
KNPTR2210	KNTR2210	2200 x 1000
KNPTR2010	KNTR2010	2000 x 1000
KNPTR1810	KNTR1810	1800 x 1000
KNPTR1610	KNTR1610	1600 x 1000
KNPTR1410	KNTR1410	1400 x 1000
KNPTR24	KNTR24	2400 x 800
KNPTR22	KNTR22	2200 x 800
KNPTR20	KNTR20	2000 x 800
KNPTR18	KNTR18	1800 x 800
KNPTR16	KNTR16	1600 x 800
KNPTR14	KNTR14	1400 x 800



Circular Panel End

Metal Frame

KNPTC16	N/A	ø1600
KNPTC14	N/A	ø1400
KNPTC12	KNTC12	ø1200
KNPTC10	KNTC10	ø1000
KNPTC08	KNTC08	ø800



Boat Shaped

KNPTB24	EX10 Panel End	2400 x 1000 x 800
KNPTB22	EX10 Panel End	2200 x 1000 x 800
KNPTB20	EX10 Panel End	2000 x 1000 x 800
KNPTB18	EX10 Panel End	1800 x 1000 x 800
KNPTB16	EX10 Panel End	1600 x 1000 x 800
KNTB24	X10 Metal Frame	2400 x 1000 x 800
KNTB22	X10 Metal Frame	2200 x 1000 x 800
KNTB20	X10 Metal Frame	2000 x 1000 x 800
KNTB18	X10 Metal Frame	1800 x 1000 x 800
KNTB16	X10 Metal Frame	1600 x 1000 x 800



Starter unit

EX10 X10
Panel End Metal Frame

KNPBET16	KNBET16	1600 x 1400
KNPBET1612	KNBET1612	1600 x 1200



Add-on end unit

KNPBECT14A	KNBET14A	1600 x 1400
KNPBET1612A	KNBET1612A	1600 x 1200



Add-on centre unit

KNPBCT16A	KNBCT16A	1400 x 1400
KNPBCT1412A	KNBCT1412A	1400 x 1200

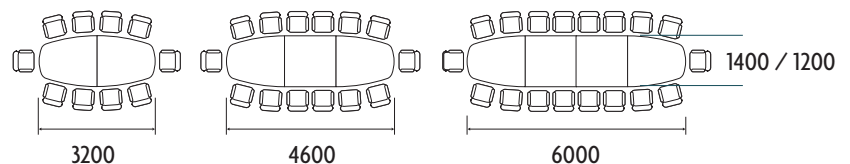



**TEN
YEAR
WARRANTY**

MOMENT tables

Seating capacities for guidance only and can differ depending on size of chair used.

Large Format Tables - Starter & Add-on Units

Large Format Tables

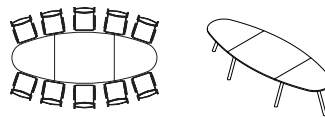

Elliptical Shaped

25mm MDF

25mm MDF
Laminated face,
chamfered edge

MWTE34	3400 x 1200	Wood leg	14
MSTE34	3400 x 1200	Steel leg	14

Starter & Add-on Units

Starter Unit

MWBET16	1600 x 1200/800	Wood leg	10
MSBET16	1600 x 1200/800	Steel leg	10

Add-On End

MWBET16A	1600 x 1200/800	Wood leg	10
MSBET16A	1600 x 1200/800	Steel leg	10

Add-On Centre

MWCT16A	1600 x 1200/800	Wood leg	10
MSCT16A	1600 x 1200/800	Steel leg	10

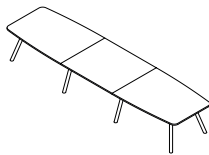

Setup Example

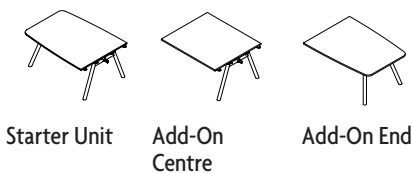

Starter Unit

Add-On
Centre

Add-On End

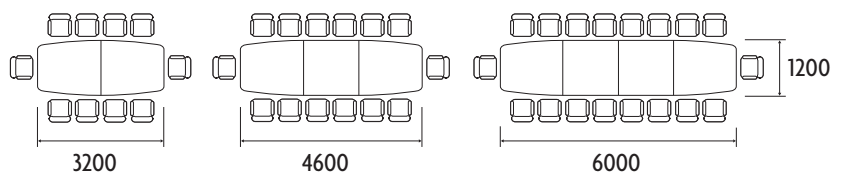

3200

4600

6000

1200

MOMENT wooden leg tables

- Elegant Table system designed with legs positioned to enable users to sit at all sides.
- Available in a variety of sizes and footprints
- Steel leg option also available - price on application

Rectangular

		25mm MDF	25mm MDF Laminated face, chamfered edge
MWTR2410	2400 x 1000	14	
MWTR2210	2200 x 1000	12	
MWTR2010	2000 x 1000	10	
MWTR1810	1800 x 1000	08	
MWTR1610	1600 x 1000	06	
MWTR1410	1400 x 1000	04	
MWTR2408	2400 x 800	14	
MWTR2208	2200 x 800	12	
MWTR2008	2000 x 800	10	
MWTR1808	1800 x 800	08	
MWTR1608	1600 x 800	06	
MWTR1408	1400 x 800	04	

Square

MWTR1212	1200 x 1200	04
MWTR1010	1000 x 1000	04

Circular

MWTC12	ø1200	04
MWTC10	ø1000	04

Boat Shaped

MWTB24	2400 x 1000/800	14
MWTB22	2200 x 1000/800	12
MWTB20	2000 x 1000/800	10
MWTB18	1800 x 1000/800	08
MWTB16	1600 x 1000/800	06

Lozenge Shaped

MWTL24	2400 x 1000/800	12
MWTL22	2200 x 1000/800	10
MWTL20	2000 x 1000/800	08

Oval Shaped

MWTE16	1600 x 1100	04
--------	-------------	----

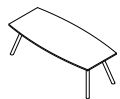
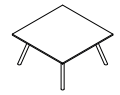



**Rectangular
740h**

MFC
25mm Laminate

AL2010RC	2000x1000
AL1810RC	1800x1000
AL1610RC	1600x1000
AL2008RC	2000x800
AL1808RC	1800x800
AL1608RC	1600x800
AL1408RC	1400x800
AL1208RC	1200x800



**Rectangular
740h**

MFC
25mm Laminate

AL2414RC	2400x1400	n/a
AL2214RC	2200x1400	n/a
AL2014RC	2000x1400	n/a
AL2412RC	2400x1200	
AL2212RC	2200x1200	
AL2012RC	2000x1200	



**Rectangular
740h 2 piece Tops**

MFC
25mm Laminate

AL4014RC	4000x1400	n/a
AL3214RC	3200x1400	n/a
AL3212RC	3200x1200	
AL3012RC	3000x1200	
AL2812RC	2800x1200	



AD-LIB TABLES

The Ad-lib programme designed by PearsonLloyd has been developed principally to work with the Ad-Lib seating range - and shares common design values and architecture.

Similar goals of lean material usage and sustainability were key to its development, as was the desire to develop a truly universal table programme with a very small inventory of components.



Circular
1020h

MFC
25mm Laminate

AL10RD	1000 dia
AL08RD	800 dia



Soft Rectangular
740h

MFC
25mm Laminate

AL2414SR	2400x1400	n/a
AL2212SR	2200x1200	
AL2610SR	2600x1000	
AL2410SR	2400x1000	
AL2210SR	2200x1000	
AL2010SR	2000x800	
AL1809SR	1800x900	



Soft Rectangular

740h 2 piece Tops

MFC
25mm Laminate

AL3214SR	3200x1200	
AL4014RC	4000x1400	n/a



Circular
740h

MFC
25mm Laminate

AL15RD	1500 dia	n/a
AL12RD	1200 dia	

PRIME TABLES

PRIME is the ultimate expression of Boardroom luxury. Dynamic, user friendly and finished to market leading standards, the PRIME system is sure to become the stunning centre piece of any boardroom and conference room environment it occupies.

Able to be specified in an infinite number of styles and finish options, from contemporary to classic, PRIME is the most advanced, fully defined flexible boardroom system. Cleverly engineered to be efficient and robust with market leading flexibility.





WILLIAM HANDS
BRITISH FURNITURE MAKERS

ORION SOFT OVERSTITCH

All Orion Soft Overstitch Executive swivel and cantilever chairs are supplied with an additional overstitch detail to the perimeter of each individual soft support pad and seat surround. Chrome arms and upholstered arm pads come as standard.

Please contact us for bespoke prices



INFINITY TABLES

INFINITY has been specifically designed to be the most complete and fully integrated meeting, conference and boardroom table system we have ever produced. With a feeling of superior quality evident on every surface, edge and user feature, each piece exudes an aura of professionalism and a vision of success.



PRECEPT SWIVEL & CANTILEVER

Cool, crisp and contemporary, it is practical and equally as comfortable as a work chair at a desk or at a meeting table. The swivel models have either an easily adjustable height and lockable tilt mechanism or a memory return mechanism for use in boardroom settings.

Please contact us for bespoke prices



TRANSCEND TABLES

Our most versatile and extensive conference and meeting platform. Clean lines and a timeless aesthetic embody the design philosophy. Cleverly engineered to be efficient and robust with market leading flexibility. These unique qualities mean the range can be universally specified enhancing any meeting, conference and boardroom environment. Beautifully finished top surfaces, hand-crafted from the finest, sustainable natural veneers and solid timbers all elevated by an elegant chrome riser.



HAVEN

Haven redefines the modular upholstery system with sofas, stools, tables and screens. The optional high back of the sofa provides excellent personal privacy, a haven, within a busy world.

A place for personal contemplation or interaction amongst a team.

RECEPTION SEATING

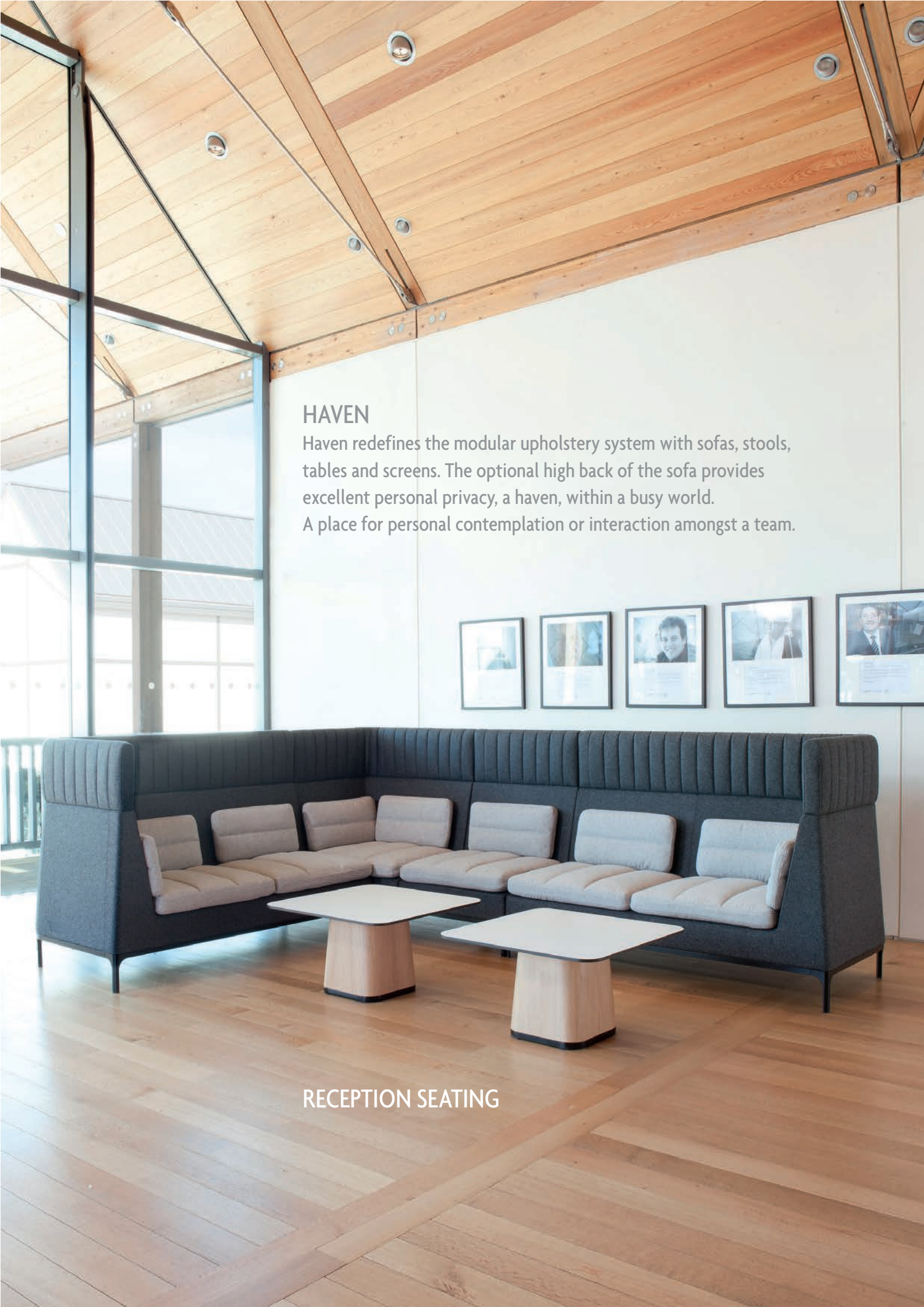



HAMMP10/MAMMPT2
HAVEN linking panel
with table
(excluding monitor)



HAM101HRRH
HAVEN single seat right hand
corner unit with headrest
(shown) LH available



HA102HR
HAVEN single seat
armchair with headrest



HA202HR
HAVEN 2 seat sofa
with headrest



HAM201HRRH
HAVEN 2 seat left hand corner
unit with headrest



HAO104
HAVEN rectangular
ottoman 780mm



HAM201HRLH
HAVEN two seat left
hand corner unit
PRICED IN BAND 3 FABRIC



**FIVE
YEAR
WARRANTY**

TAKE UP

Take Up modular soft seating is a combination of low benches and high back sofas, ideal for situations where privacy is required in an open plan environment. The design combines smooth ergonomic shapes with strength and stability, creating a truly impressive seating range.

In addition, Take Up neatly accommodates an acoustic system with power, data and communication modules, creating an exclusive solution for both collaborative and interactive working.



TKUMD
TAKE UP 2 tier with
arms



TKULS
TAKE UP 3 tier



TKUML
TAKE UP with left arm

TKUMR
TAKE UP with right arm



TAKE UP meeting pod

TAKE UP booth





TAKE OFF

A range of modular bench style seating designed to complement breakout and reception areas. Comprising of 17 models, including four tables, Take Off can be configured to truly enhance the aesthetics and functionality of almost any space.



AS06FA
TAKE OFF full back with arms
1600w x 640d



AS06FB
TAKE OFF full back 2 seater
1200w x 640d



AS06LBA
TAKE OFF half back with left arm
1400w x 640d



AS06TB
TAKE OFF 2 seater twin back
1400w x 640d



AS06LB
TAKE OFF seat half back LH
1200w x 640d



AS66FB
TAKE OFF full back single seat
640w x 640d

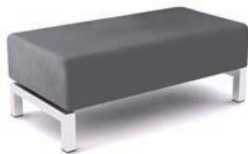

AS06
TAKE OFF without back 2 seater
1200w x 640d

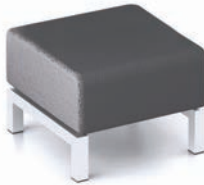

AS66
TAKE OFF without back single seat
640w x 640d

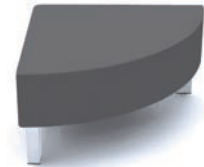

ASQ
TAKE OFF without back quadrant
640wW x 640d

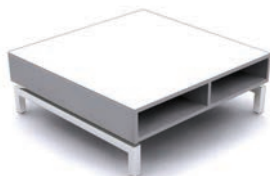

A1212Z
TAKE OFF quadrant square table
1200w x 1200d x 450h



ATRZ
TAKE OFF radial table
1200w x 600d x 450h

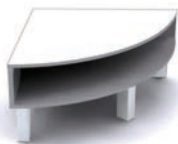

ATQZ
TAKE OFF quadrant table
630w x 630d x 450h

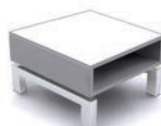

AO606Z
TAKE OFF quadrant square table
630w x 630d x 450h





LRI
One seater bench



LR2
Two seater bench



LR1B
One seater bench with back



LR2B
Two seater bench with back

PRICES SHOWN IN BAND 1 FABRIC



**FIVE
YEAR**
WARRANTY

CALL FOR
FREE
COLOUR
SWATCHES

EVERYDAY BENCH RECEPTION SEATING

A compact range of modular bench seating and tables designed to provide a single effective solution for waiting and reception areas, as the name suggests.



ERL5
600 x 600 table



ERL6
750 x 750 table



ERL7
1000 x 600 table



EVERYDAY HIGH BACK SOFA

The simple crisp styling of the high back sofa group has been developed to respond to the growing demand for this type of seating in the workplace. Available as a single and two seat unit with complementary tables, it is sure to suit a multitude of applications.



EL1
Single seater/highback



EL2
Two seater/
highback

RECEPTION SEATING



RECEPTION SEATING



EVERYDAY RECEPTION SEATING

Simple and deliberately understated styling is the hallmark of this seating group. The carefully considered upholstery piece delivers the perfect solution for reception environments.



ERL1
Single seater



ERL2
Two seater



ERL5
600 x 600 table



ERL6
750 x 750 table



ERL7
1000 x 600 table

EVERYDAY ELEMENTS

This up-to-the-minute, stylish upholstered seating is specifically designed to fulfil both the aesthetic and functional requirements of a contemporary reception space.



Cube
465h

BR1	400 x 400
-----	-----------



Short bench unit
465h

BR2	600 x 400
-----	-----------



Curved unit
465h - 90° curve

BRQ1	90° x 400
------	-----------



Long bench unit
465h

BR3	1000 x 400
BR4	1200 x 400
BR5	1800 x 400



High back unit
810h

BR2B	600 x 200
BR3B	1000 x 200
BR4B	1200 x 200
BR5B	1800 x 200



RECEPTION SEATING



**FIVE
YEAR**
WARRANTY

EVERYDAY TUB RECEPTION

The simple, crisp styling of Everyday Tub Reception seating has developed in response to growing demands in the workplace.



CH2
Fully upholstered sofa



CHI
Fully upholstered armchair

ALVIER

This elegant soft seating collection comprises a single and two seater sofa and bench option which are both available in three differing leg frames, wooden, steel tubular and sled frame.

The square back chair and sofa is available with both loose and fixed cushions and incorporates a tapered armrest for added comfort and aesthetic appeal. The range comes with coffee tables available in a variety of tops and finishes making it the perfect collection for breakout, reception, hotel lobby or executive office seating.

NSCB Loose piped buttoned cushion **£75.00**

NS2HM 2 seater fixed cushion sofa tube leg

NST069M coffee table tube leg - 980w x 680d x 275h

**FIVE
YEAR**
WARRANTY

CALL FOR
FREE
COLOUR
SWATCHES



NS2HS 2 seater fixed cushion sofa sled leg



NS1HM fixed cushion chair tube leg



NS2HS as above shown in Band 3 fabric



NS1HW fixed cushion chair wooden leg



NS2HW 2 seater fixed cushion sofa wooden leg

NS1BW/NSCP Chair with arms & loose cushion wooden leg

NSCP Plain cushion

NST069W Coffee table 980w x 680d x 275h

NS2W 2 seater large bench wooden leg

Wood frame colours in Natural or Dark Walnut

CONIC

Conic is a refreshing, eye catching and exciting take on various conical forms previously explored in soft seating. The range comprises of three versions including low lounge chairs and a more compact, higher tub variant.



A630
Tub chair chrome
wire frame



A632
Lounge chair with headrest
chrome wire frame



A631
Lounge chair
chrome wire frame



A637
Tub chair with four
chrome legs

PRICES SHOWN IN BAND 1 FABRIC

OPEN

Open is an elegant and relatively compact, contemporary collection of soft seating, with chair and sofa sharing a formed steel rod, base frame aesthetic. Angular and striking, they lend a physical lightness to the appeal of the design.

The moulded seat shells and cushions with 'bull nosed' edge profile, economic detailing and tailored upholstery, provide great comfort, precise shape, a simple pleasing form and visual slenderness. Great for lounges, visitor and reception areas or even meeting rooms.



A644
Lounge sofa
chrome wire frame



A640
Lounge chair
centre column



A641
Lounge chair centre
column with headrest



A642
Lounge chair
chrome wire frame



A643
Lounge chair chrome
wire frame with headrest

PRICES SHOWN IN BAND 1 FABRIC





A620
Seat



A621
Scalloped seat



A622
Table topped
Band A laminate

PRICES SHOWN IN BAND 1 FABRIC



PEBBLE

Pebble is a superb seating option for informal meeting spaces or corporate breakout areas.

This comfortable design allows creativity with colour and shape as they can be nested together to create infinite combinations.

CALL FOR A
FREE
TRIAL SERVICE
OR VISIT OUR
ERGO SHOWROOM

ALLERMUIR BISON CHAIR

A highly stylish and distinctive compact tub chair designed by Simon Pengelly. Despite its compact size, the Allermuir Bison is surprisingly comfortable due to its flexible arms, backrest and sprung seat. Please note - colour selection is for a single colour chair only. 2 tone chairs are available.



BNI
Tub chair

HAS040L
Static low stool

PRICES SHOWN IN BAND 1 FABRIC

VENUS

Venus is a versatile, compact tub chair with a moulded foam body and sprung seat providing excellent comfort for informal and formal meeting, conference and dining applications.

The many practical features such as sloping arms, recessed under seat area and generous backrest have all been incorporated into the design with flowing lines and a refreshing profile that enhances the visual elegance of what is otherwise a very simple, classic styled tub chair.



VSI
Tub chair

PRICES SHOWN IN BAND 1 FABRIC

FIVE
YEAR
WARRANTY

**FIVE
YEAR
WARRANTY**

STRATT PLUS

Optional wooden or chrome leg
Reconfigurable in a vast array
of configurations



R8CURPW

Small curve 45°

Wooden leg
Chrome leg



R16CURPW

Large curve

Wooden leg
Chrome leg



STR1W

1 seater

Wooden leg
Chrome leg



STR2W

2 seater

Wooden leg
Chrome leg



STR3W

3 Seater

Wooden leg
Chrome leg



MOTILE



MOSI
Spider base



MOFI
Square flat base



MOSA
Spider base with arms



MOFBA
Square flat base
with arms

NEOS



NPE4S
Spider base



NPECB
Central pedestal base
(height adjustable)



NPESB
Swivel five star base with
castors (height adjustable)

TEAM UP

Anytime, anywhere.



A clever multi-purpose seating range comprising four different models and a stacking chair.

The range has been designed to suit various areas throughout the work place. Options include a low or high back, two arm versions and three different frames.

Seat shells can be specified as either oak veneer or HPL, and combined with upholstered seat and back pads.

TEAM UP MEET



TUPR 3 OAK HP

High back, oak HPL or oak veneer, seat & back pad, polished chrome gas stem.

Options

Wooden arms
AO Tube arms
TA Tube arms white
TAW Tube arms yellow
TAY Tube arms any colour

TEAM UP RELAX



TUT 5P

High back, fully upholstered, polished chrome frame.

Options

Wooden arms
AO Tube arms
TA Tube arms white
TAW Tube arms yellow
TAY Tube arms any colour



TEAM UP CONNECT



TUWTR 2 OAK HP

Low back, integrated tablet, oak HPL or oak veneer, seat & back pad, polished chrome frame.

TEAM UP BENCH



TUB3 000 OAK H

Three seat bench, low back, oak HPL or oak veneer, no upholstery

TEAM UP STACK



TUR 2 OAK HP

stacking chair, oak HPL or oak veneer, seat & back pad, polished chrome skid frame

Options

- Two seat bench
- Four seat bench
- Five seat bench

Options

- No upholstery
- Upholstered seat
- Fully upholstered



IZZEY LITE

Izzy Lite is a playfully stylish chair that coordinates with the rest of this winged backed range. Where other family members create enclosed, personal space, 'Lite' encourages users to interact with the world around them. This compact tub chair is designed for relaxed, informal gatherings where small clusters can be arranged together. Perfect for contemporary socialising.



IZLT
Armchair
static

Single colour fabric
2 tone fabric



IZLTPX
Armchair static c/w
UK power socket

Single colour fabric
2 tone fabric



IZLTPU
Armchair static c/w
twin charger unit

Single colour fabric
2 tone fabric



IZLW
Armchair
mobile

Single colour fabric
2 tone fabric

IZZEY

Redefining traditional high, winged back reading chairs, Izzy offers an inviting retreat for those seeking personal space. This armchair and sofa family is ideal for informal, discreet meetings or individual relaxation. Available with two back heights, in single and twin seat options that satisfy simple privacy requirements in open plan areas.



IZL02
Low back 2 seater

IZL01
Low back 1 seater



IZH2
High back 2 seater

IZH1
High back 1 seater

LUX

The Lux tub chair range comprises six fully upholstered pieces. Featuring elegant sewing details, buttons in the back and tapered solid oak legs. A complementary table range is available.

The new soft seating range is versatile in use, ideal for the fast paced work environment. Different combinations create flexible space for discussing, presenting, brainstorming and relaxing.



**FIVE
YEAR**
WARRANTY

LUX1

Single seat tub chair



LUX2

2 seat tub sofa



LUX1W

High back wing chair



LUXOT1

Single seat Ottoman



LUXOT2

2 seat Ottoman



LUX2W

High back wing sofa



**FIVE
YEAR**
WARRANTY

CALL FOR
FREE
COLOUR
SWATCHES

JIGSAW 2

A modular stool and bench system consisting of nine interlocking shapes. Ideal for any open space for a quick touchdown or meeting with colleagues.

Bold, contemporary and redesigned to make an impact, Jigsaw2 offers a range of angular and circular modules that create limitless configurations and creative seating landscapes.



JIG2-DIA-55
Round stool



JIG2-165
1650 bench



JIG2-PIECE
V section bench



JIG2-SQU-55
Cube stool



JIG2-110
1100 bench



JIG2-WED
Wedge shape stool



JIG2-DIA-80
Low round stool



JIG2-SQU-80
Low cube stool



JIG2-SQU-45
High cube stool

HAVEN PODS

The open office has delivered many benefits; however there is a need for privacy within the workplace environment. Haven Pods provide a defined space for individual focused work and spaces for team collaboration.

The space efficient geometric design also enhances the acoustic performance of the product.



**FIVE
YEAR**
WARRANTY



HAPDD18
Compact 2 person
meeting space
complete



HAPDSP18L/R
Single person
workspace full height



HAPDTM18
Team meeting space
complete



HAPDSQ18
Four person
meeting space
complete



HAPDS518L/R
Compact single person
workspace



BAUDOT

Baudot is a beautiful example of where form meets function. As well as making a visual impact in any area, the range can also be used in acoustic landscaping, as a solution to noisy environments such as open plan offices, atria and hospitality. Freestanding and wall mounted options can be specified to achieve a variety of fun looks.



BDZ5
Wall mounted
wood frame
755mm dia.



BDZ2
Wall mounted
510mm dia.



BDSR12
BAUDOT STRINGS



BDZ1
ZERO
FREESTANDING

STUDIO

The new Studio range of Acoustic Pods is truly a product for every occasion.

Split into three defined ranges, the Studio Pod system includes the StudioWork study area range, StudioBooth seating pods and the StudioSpace - designed to create segmented meeting areas in open plan offices.



Study Pod 4 person

1400h



Media Wall

1400h c/w table



4 Person Booth

1400h c/w seating & table

1600h c/w seating & table

1800h c/w seating & table

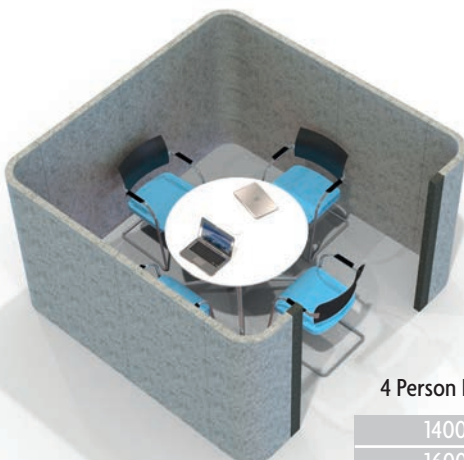

4 Person Pod

1400h c/w table

1600h c/w table

1800h c/w table

FLITE

Flite screens are a modern, stylish and cost effective space dividing solution, fully upholstered in a choice of fabrics with a PVC trim available in white, silver or graphite grey.

Flite screens are 26mm thick and feature screen top contours that include, straight, curved and wave options.



Flite Desk Mounted Screens

Width	600mm	800mm	1000mm	1200mm	1400mm	1600mm	1800mm
380mm high							
Straight top							
Curved top							
Wave top							
480mm high							
Straight top							
Curved top							
Wave top							

Flite Freestanding Screens

Width	600mm	800mm	1000mm	1200mm	1400mm	1600mm	1800mm
1000mm high							
straight top							
curved top							
wave top							
1200mm high							
straight top							
curved top							
wave top							
1400mm high							
straight top							
curved top							
wave top							
1600mm high							
straight top							
curved top							
wave top							
1800mm high							
straight top							
curved top							
wave top							

Stabilising feet available

**FIVE
YEAR**
WARRANTY

CALL FOR
FREE
COLOUR
SWATCHES



SPRINT

Sprint screens are a modern, stylish and cost effective space dividing solution with a choice of white, silver and graphite grey frames.

Available in desk mounted and freestanding versions, Sprint screens are constructed with a 30mm aluminium frame with top options including straight, curved and wave.

Sprint Desk Mounted Screens

Width	600mm	800mm	1000mm	1200mm	1400mm	1600mm	1800mm
380mm high							
Straight top							
Curved top							
Wave top							
480mm high							
Straight top							
Curved top							
Wave top							



Sprint Freestanding Screens

Width	600mm	800mm	1000mm	1200mm	1400mm	1600mm	1800mm
1000mm high							
straight top							
curved top							
wave top							
1200mm high							
straight top							
curved top							
wave top							
1400mm high							
straight top							
curved top							
wave top							
1600mm high							
straight top							
curved top							
wave top							
1800mm high							
straight top							n/a
curved top							n/a
wave top							n/a

WOOD GRAIN BOARD FINISHES

Superior high impact resistant edging is used on all our board finishes in preference to the less environmentally friendly Polyvinyl Chloride (PVC). Apple, Ash and Light Oak 36mm edging is not available.



SCRIPT - ACCENT COLOURS FOR DOORS & DRAWER FRONTS



METAL FINISHES

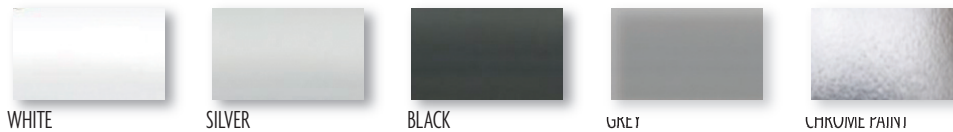

Why Chrome paint? Due to the impact of the toxic chemicals used in chrome our chrome paint offers a similar look without treatment to dispose of the waste.

SIERRA VINYL

SIERRA FEATURES • Medium hazard - suitable for a wide range of heavy duty applications including medical • Base colour used throughout the coating process so scuff marks are almost invisible • Sierra+ contract vinyls are easy to use, easy to clean and are available in a wide variety of colours. Sierra+ now has antimicrobial and antibacterial protection that resists gram negative and gram positive bacteria (including MRSA), filamentous fungi and yeast.



A key characteristic of vinly surfaces as opposed to most surfaces, is that they are hydrophobic. They do not absorb water, they do not retain dampness and they can be completely dried after washing. Research has confirmed that the viability of MRSA bacteria is greatly reduced in dry environments.

SEATING FABRICS



GRANITE **AD009**



LARGO **AD112**

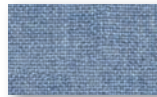

SEA BLUE **AD017**



OASIS **AD117**



RED **AD014**



SANDVALE **AD016**



GRAPHITE **AD066**



CLIPPER **AD126**



ADRIATIC **AD001**

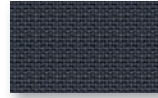

AQUA **AD009**

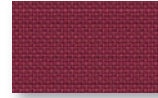

RASPBERRY **AD127**



TAWNY **AD098**



BLACK **AD055**



NIGHTSHADE **AD011**



COBALT **AD009**



AZTEC **AD113**



WINE **AD020**



FOX **AD119**

ADVANTAGE



SLIP **YS094**



STEEL **YS095**



BLUEBELL **YS097**



APPLE **YS096**



BRIDGETOWN **YS102**



SOLANO **YS072**



SOMBRERO **YS046**



MARTINIQUE **YS004**



SCUBA **YS082**



MONTSERRAT **YS011**



DIABLO **YS101**



LOBSTER **AD076**



HAVANA **YS009**



CAYMAN **YS024**



OCEAN **YS100**



TABOO **YS045**



TAROT **YS084**



CALYPSO **YS106**

PHOENIX



NORMAL
EIGHT HOUR
USAGE

SCREEN FABRICS

CARA FEATURES • Cara is a Second Nature branded product made from 100% recycled polyester using non metallic dyestuffs • Diverts waste from landfill and saves virgin raw materials • Colour palette is designed to coordinate with the Xtreme plus range for seating • Easy clean low maintenance product - just wipe fresh stains clean away with a damp cloth.

CARA



NORMAL
EIGHT HOUR
USAGE

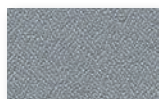

SLIP **YB094**

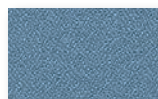

STEEL **YB095**



BLUEBELL **YB097**



APPLE **YB096**



BRIDGETOWN **YB102**



SOLANO **YB088**



SOMBRERO **YB046**



MARTINIQUE **YB004**



SCUBA **YB089**



MONTSERRAT **YB011**



DIABLO **YB101**



LOBSTER **YB087**



HAVANA **YB009**



CAYMAN **YB024**



OCEAN **YB100**



TABOO **YB045**

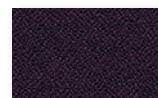

TAROT **YB090**



CALYPSO **YB106**

ALL SEATING PRICES IN ADVANTAGE FABRIC UNLESS OTHERWISE STATED



We have a dedicated customer service team waiting to advise you. Should you be unable to find what you are looking for - please either call us on

FREEPHONE 0808 144 1034

or email us at sales@centric-office.co.uk

**UNIT 2 ANDREWS COURT, ANDREWS WAY,
BARROW IN FURNESS, CUMBRIA, LA14 2UE.**

visit us online: www.centric-office.co.uk